

PANELS
+ SHOWER TRAYS
+ COMPONENTS

marmox[®]

TO **TILE**

WETROOM SYSTEMS

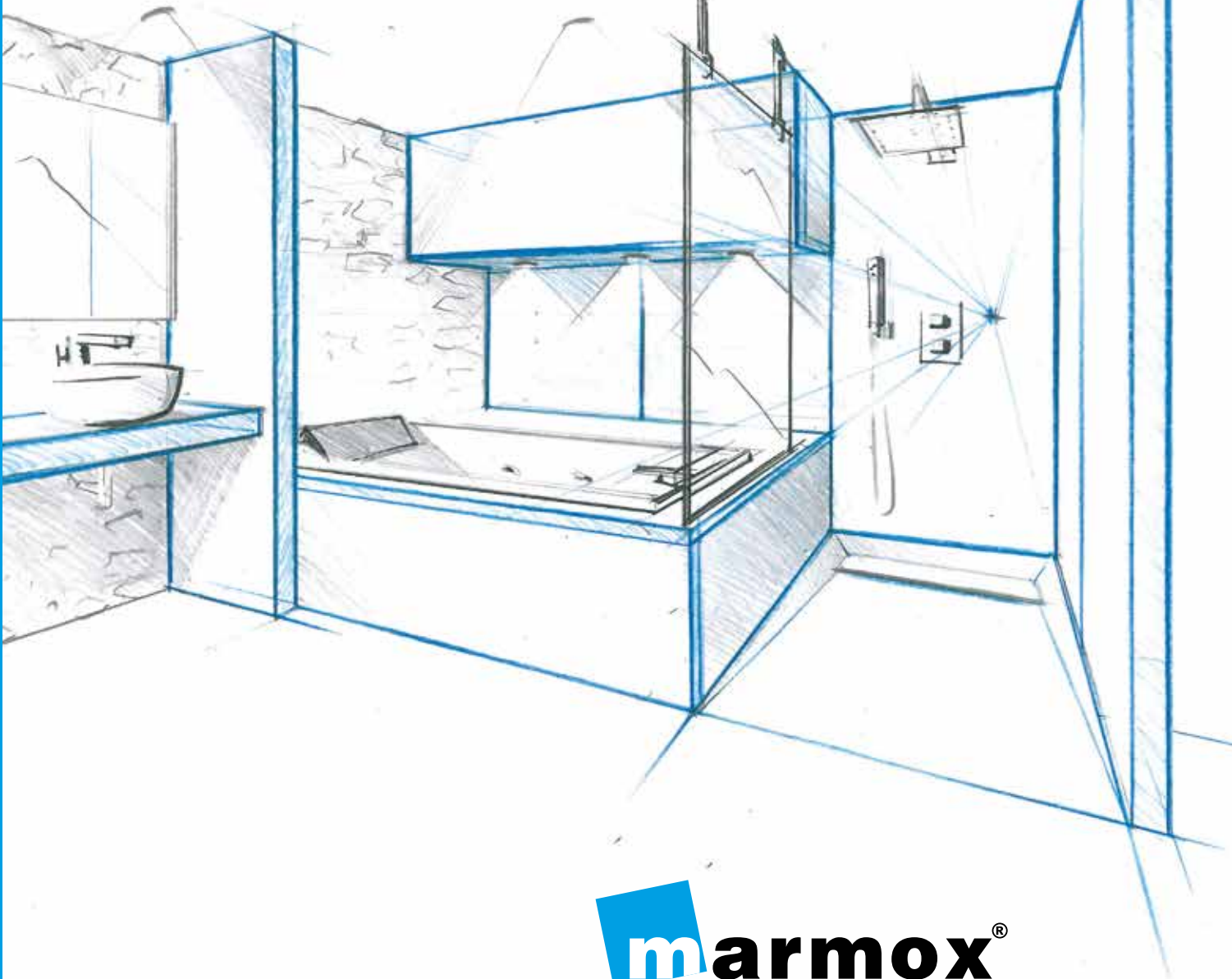

marmox[®]
MEMBER OF CMB GROUP

Systeme de douche
à encastrement

Panneaux
pour sup
double b

Panneaux d'anchorage
en recouvrement
mural 20 mm

Gaijssan avec
lumiere integree

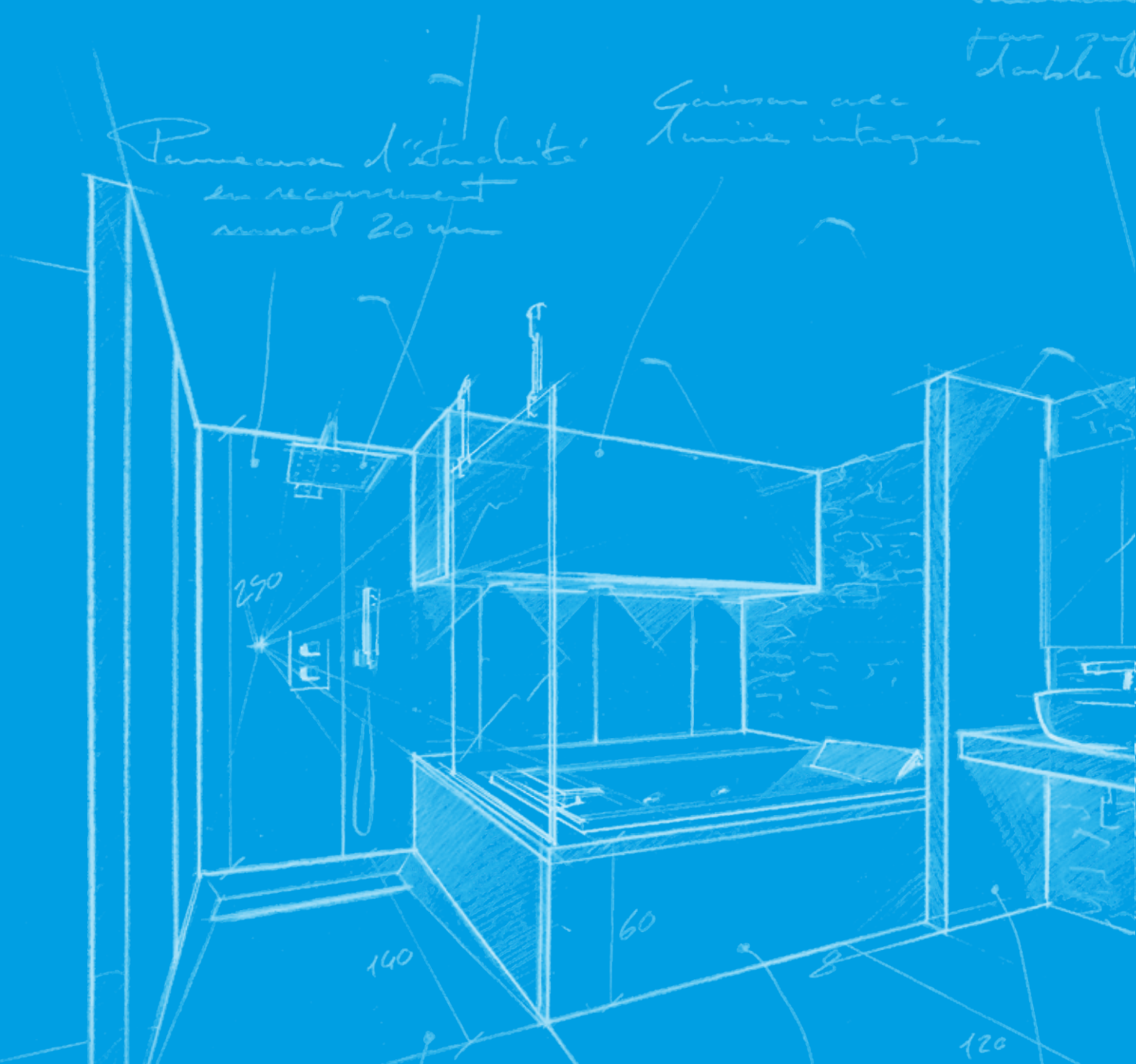

READY-TO-TILE CONSTRUCTION PANELS

- 9 — PIPE BOXING PANELS
- 10 — BATH PANELS / TOILET CISTERN PANELS
- 11 — FLEX PANELS
- 12 — SHELVES / NICHES
- 14 — MARMOX MULTIBOARD
- 15 — Marmox ULTRABOARD
- 16 — MARMOX ML PANEL
- 17 — MARMOX THE TILEBACKER
- 18 — MARMOX THERMOROCK
- 20 — MARMOX SOUNDBOARD
- 21 — MARMOX SLOPED BOARD

HAMMAM

- 22 — BESPOKE HAMMAMS

FLOOR DRAIN SOLUTIONS

- 30 — MINILAY - SHOWER FLOOR DRAIN - 360° JAMES
- 31 — MINILAY - SHOWER FLOOR DRAIN - ULTRA FLAT - SLIM
- 32 — MINILAY - SHOWER CHANNELS
- 33 — MINILAY - SHOWER CHANNELS - NEW GENERATION

READY-TO-TILE SHOWER TRAYS

- 40 — STANDARD GRIDS
- 41 — CHANNEL GRIDS
- 42 — SHOWERLAY - TILEABLE SHOWER TRAYS - FLAT BOARD®
- 43 — SHOWERLAY - TILEABLE SHOWER TRAYS - SLIM BOARD®
- 44 — SHOWERLAY - TILEABLE SHOWER TRAYS - COMPACT BOARD®
- 45 — SHOWERLAY - TILEABLE SHOWER TRAYS - COMPACT BOARD® LINE
- 46 — SHOWERLAY - TILEABLE SHOWER TRAYS - MONO BOARD®
- 47 — SHOWERLAY - TILEABLE SHOWER TRAYS - LINE BOARD®
- 48 — SHOWERLAY - TILEABLE SHOWER TRAYS - FLAT BOARD® KIT COMPLETE
- 49 — SHOWERLAY - TILEABLE SHOWER TRAYS - LINE BOARD® KIT COMPLETE

50 — SUMMARY DIMENSION TABLES

80 mm support
the Casque



the construction

Marmox is part of the CMB group of companies, CMB manufactures and distributes a range of specialist building products for the construction industry in over 50 countries.

Marmox has been one of the world's leading building panel companies for over 30 years.

In 2013, Marmox introduced the famous honeycomb finish- a patented coating of the Marmox Multiboard.

In 2017 we introduced the Marmox Ultra panel, a new type of tileable panels with excellent waterproof properties, easier to cut and lighter in weight.

The Marmox building panel is the base material for a global range that is focused on renovating and building quality stylish bathrooms. Beyond the traditional ranges of tileable panels that enable you to clad and build walls, floors and bathroom furniture, our aim is to offer our distributors and customers, a complete and unique range of waterproof wet room systems.

We have developed three innovative solutions for you to make the barrier-free shower of your choice:

- Minilay - Traditional floor drain solutions.
- Marmox Showerlay - a tileable showerunderlay.
- The Marmox Swan Range – Contemporary designer shower trays & wall panels made from highly durable composite resins or beautiful natural stone materials.



WATERPROOF
LIGHTWEIGHT
EASY TO CUT
READY TO TILE
READY TO PLASTER

READY TO TILE

CONSTRUCTION PANELS

WATERPROOFING AND INSULATION OF FLOORS, WALLS AND CEILINGS

UNDERFLOOR HEATING INSULATION

BATHROOM PARTITION WALLS

STEAM ROOM WALLS

FABRICATION OF TILED BATHROOM FURNITURE

ROOF INSULATION SYSTEM

DECORATIVE AND ARCHITECTURAL FACADE DESIGNS

COVERING EXTERIOR STEEL FRAME STRUCTURES

USE AS AN EXTERNAL TILE BACKER OR AS A RENDER BOARD

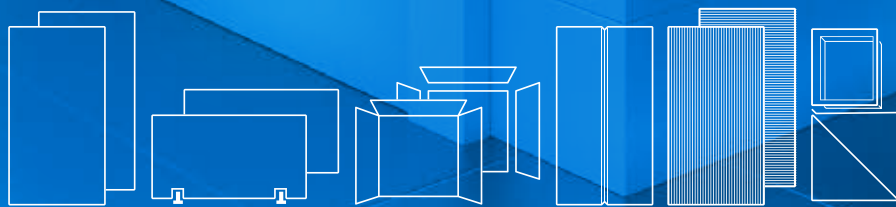

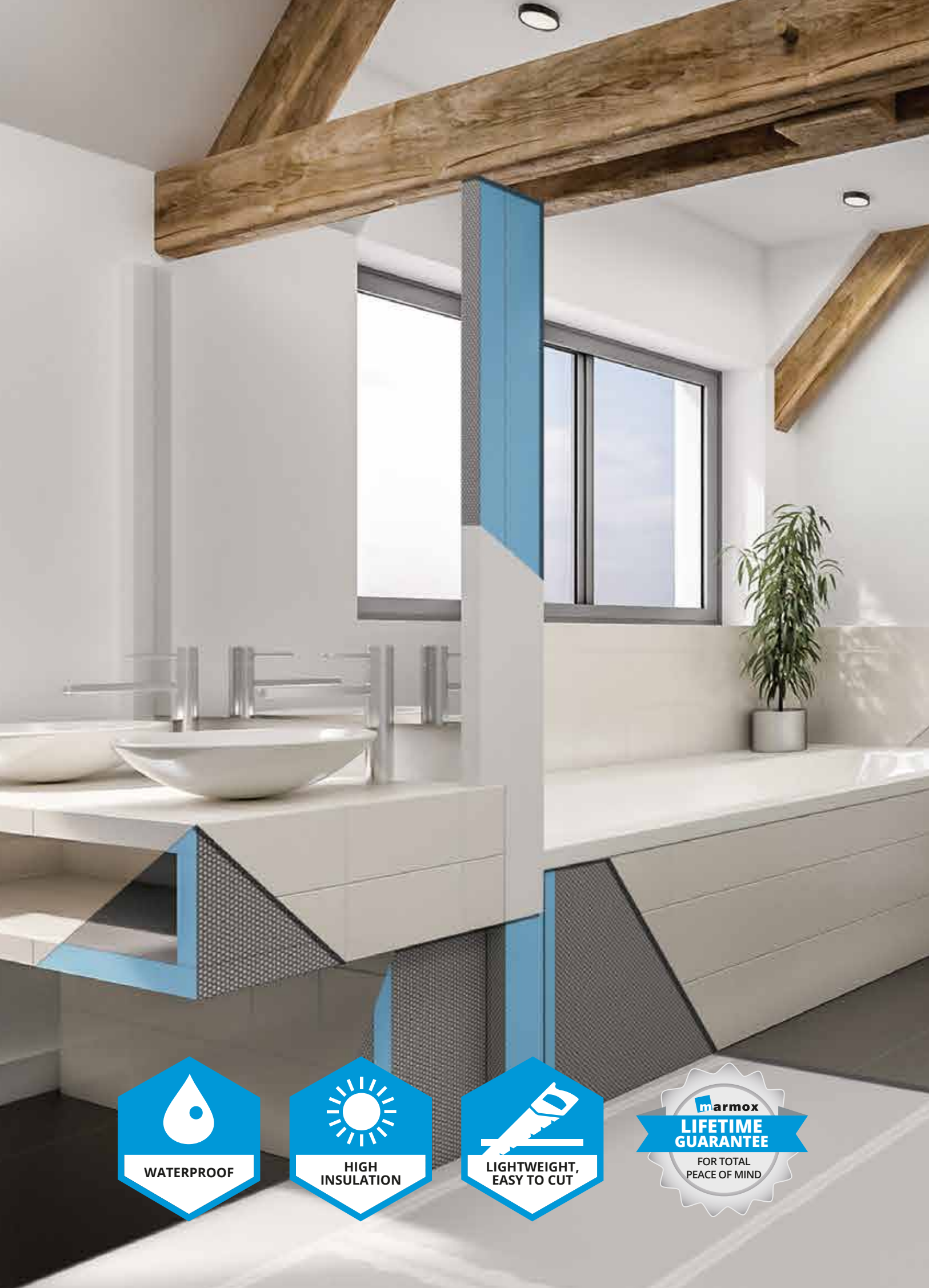





Different types of construction panels :

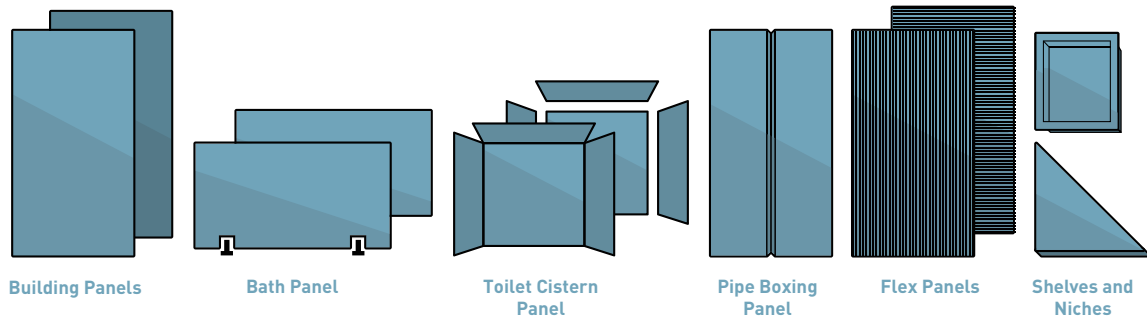

Description	Test	Result
Thermal Conductivity up to 5 yrs	DIN 52612	0.034 W/mK
Compressive strength at %10 deflection	DIN 53421	400 kPa (40 tonnes/m ²) at %10 deflection
Absorption of water when immersed	DIN 53428	%0,2 per volume of water
Absorption of water (capillary)	DIN 53428	Negligible
Fire Characteristics	"BS476 PART 6.7 EN 1-13501"	Class E

Technical features of standard panels

Thickness in mm	4	6	10	12.5	20	30	40	50	80
Tile thickness adjustment	✓	✓	✓						
Levelling / Floor Covering	✓	✓	✓	✓	✓	✓	✓	✓	✓
Wall Cladding	✓	✓	✓	✓	✓	✓	✓	✓	✓
Window Forming				✓					
Toilet Cistern panels					✓	✓			
Bath panel					✓	✓			
Podiums / Plinth's							✓	✓	✓
Construction of Tiled Furniture							✓	✓	✓
Tileable Partition Walls								✓	✓
Insulation – Wall / Floor / Roof			✓	✓	✓	✓	✓	✓	✓

Where to Use

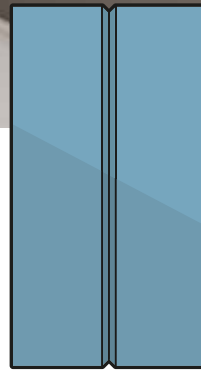

STANDARD BUILDING PANELS

Marmox building panels are ideal for interior and exterior applications. In addition to being a lightweight building panel, it is used for waterproofing, dry-lining and to provide thermal insulation.

Interior Applications:

- Waterproofing and insulation of floors, walls and ceilings
- Underfloor heating insulation
- Bathroom partition walls
- Steam room walls
- Fabrication of tiled bathroom furniture

Exterior applications:

- Covering of exterior pipes
- External Thermal Insulation System
- Car Park Ceiling Insulation
- Roof Insulation System
- Decorative and architectural facade designs
- Covering exterior steel frame structures
- Use as an external tile backer or as a render board

Panels are available on request with vapour barriers for steam rooms and Hammams.

Available in 90 cm and 120 cm wide — Other lengths on demand

PIPE BOXING PANELS

- Pipe boxing panels will help you quickly clad right angles and insulate often unsightly pipes in bathrooms
- PIPE BOX PANELS
- CORNER FORMWORK
- PIPE COVERING
- CLADDING OF STAIRS / STEPS
- LIGHT SHELVING

Pipe boxing comes in 4x widths (150 x 150 mm, 200 x 200mm, 300 x 300mm, and 400 x 200mm). Its most common use is for covering pipe work, other uses include covering steel structure, finishing pillars, stair renovation, shelving, shuttering for concrete or screed.

- Pipe boxing comes flat packed making it easy to be stored and transported, simply fold the pipe boxing into a 90 degree shape which is held in position with a length of double sided tape that came pre attached to the 45 degree mitre.

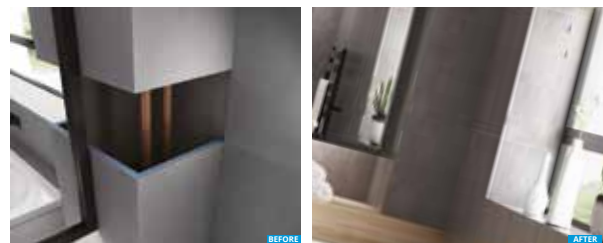

FLAT PACK DELIVERY TO AVOID BREAKAGE DURING TRANSPORTION

REF	DESCRIPTION	THICKNESS (MM)	WIDTH (MM)	LENGTH (MM)	WEIGHT PER PANEL (KG)
20 ANG 150	Pipe Box Panel 15 x 15 cm	20	150 x 150	2500	2
20 ANG 200	Pipe Box Panel 20 x 20 cm		200 x 200		2.5
20 ANG 300	Pipe Box Panel 30 x 30 cm		300 x 300		4
20 ANG 400200	Pipe Box Panel 40 x 20 cm		400 x 200		

Available from 20 to 80 mm thick on demand

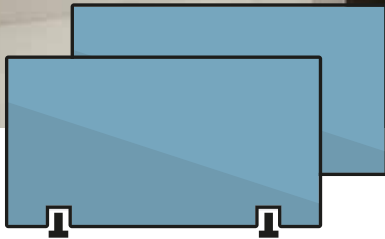

BATH PANELS

From standard bathtubs to the corner bathtub, we offer a variety of solutions to quickly enclose your bath.

• STANDARD BATHTUBS

• The bath panel consists of standard 30mm panel, pre fitted with 2x adjustable levelling feet that allows for a tight compression fit under the rim of the bath providing a rigid and stable surface ready to be tiled. Marmox Bath panels provide an economical and fast solution compared to building a tileable bath panel from wood. Being %100 waterproof, our bath panels will not deteriorate over time, in addition they provide a more aesthetic solution because they allow immediate tiling with mosaics or the same tiles as the rest of the bathroom.

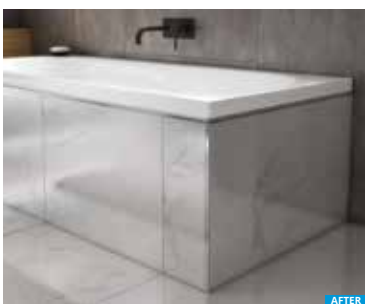

REF	DESCRIPTION	THICKNESS (MM)	WIDTH (MM)	LENGTH (MM)	WEIGHT PER PANEL (KG)	QUANTITY PER PALLET
30 EB 55 185	BATH PANEL WITHOUT FEET	30	550	1850	2.4	75
30 EB 177			600	1770	2.4	75
30 TAB 90				900	1.2	75
30 TAB 180	BATH PANEL WITH FEET	30	600	1800	2.4	75

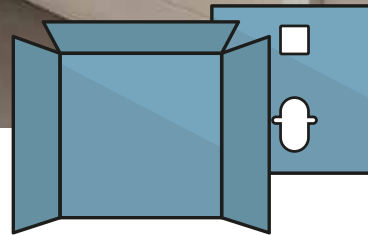

TOILET CISTERN PANEL

• CLADDING FOR WALL HUNG FRAMES

• CLADDING FOR WALK IN SHOWER FRAMES

Cladding a support frame is often problematic and costly. The support frame cladding kit allows you to build the cladding with reliability, security and speed. In addition, it is ready-to-plaster, ready-to-tile and waterproof. The proposed kit consists of 4 panels to adapt to all situations. The time saved in installing the support frame is extremely advantageous and economical: around 50% compared to traditional solutions.

The support frame cladding can also be used for wall-mounted drains of walk-in showers such as shower support frames. They will allow you in addition to the support frame shower, to be able to make a half-height shelf for household products, or to house a shower column for PRM installations.

Cladding a concealed support frame has never been easier, faster and safer than with this product designed for every building on the market.



REF	DESCRIPTION	THICKNESS (MM)	WIDTH (MM)	LENGTH (MM)	WEIGHT (KG)
TOILET BOARD	TOILET CISTERN PANEL - PRE CUT -	20	1200	1550	4
TOILET BOX	TILEABLE SUPPORT FRAME CLADDING KIT	30	600	1250	4



FLEX PANELS FOR CURVED SHAPES

The range of flex panels, available in two formats (grooving in width or length), will allow you to fit all shapes of your bathroom or creatively create irregular shapes

- LINING OF PILLARS AND COLUMNS
- LINING OF ARCHWAYS AND ROUND WINDOWS

THE VERY EASY ADJUSTMENT AND FLEXIBILITY WILL ALLOW PROFESSIONALS TO ADAPT ALL CURVED SURFACES, ALSO BRINGING CREATIVITY TO THE RENOVATION OR CONSTRUCTION OF BATHROOM FURNITURE.

REF	DESCRIPTION	THICKNESS (MM)	WIDTH (MM)	LENGTH (MM)	WEIGHT PER PANEL (KG)	QUANTITY PER PALLET
20/30 JAGL 250	FLEX PANEL - ALONG LENGTH	20/30	600	2500	3.5/4	115/75
20/30 JAGW 250	FLEX PANEL - ALONG WIDTH					



BEFORE



AFTER



TILEABLE SHELVES

What could be better than a designer touch to complete the finishing of your bathroom. This is what we offer you with an ergonomic corner shelf in trendy design. This small corner shelf and its fixing kit will fit everywhere in the bathroom and in the shower. Ideal for new or renovation.

REF	DESCRIPTION	THICKNESS (MM)	WIDTH (MM)	LENGTH (MM)	WEIGHT (KG)	QUANTITY PER BOX
TILE CORNER	TILEABLE SHELF FOR BATHROOM	30	240	240	0.5	1 Piece

Delivered in individual boxes.

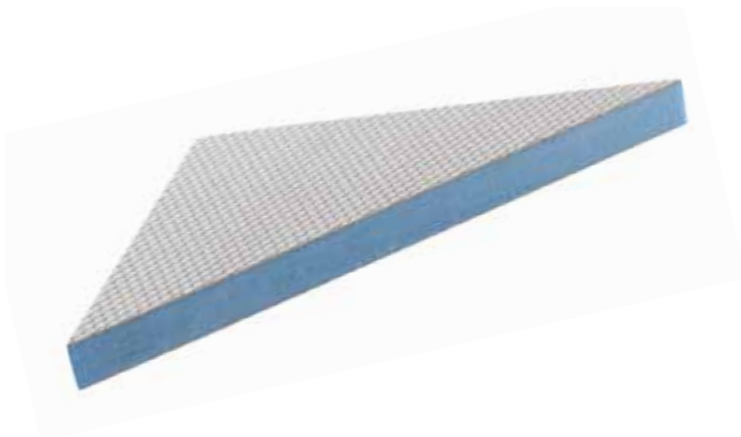

TILEABLE NICHE

Marmox shower niches are easily installed and completely waterproof. Our niches can be installed between the stud work of your partition wall or bonded into a solid wall. The Marmox niche is 12.5mm thick helping to marry it with a 12.5mm standard Marmox panel used to line the rest of the wall or lined with 12.5mm plasterboard if not used in a wetarea. Marmox Niches can be plastered if required.

REF	DESCRIPTION	THICKNESS (MM)	DEPTH (MM)	LENGTH (MM)	WIDTH (MM)	WEIGHT (KG)	QUANTITY PER BOX
NICHE 4020					200		
NICHE 4030				400	300	2	
NICHE 4040	TILEABLE NICHE FOR BATHROOM	10	100		400		1 Piece
NICHE 8025				800	250	2.5	

Available in 4 sizes. Custom sizes are possible.

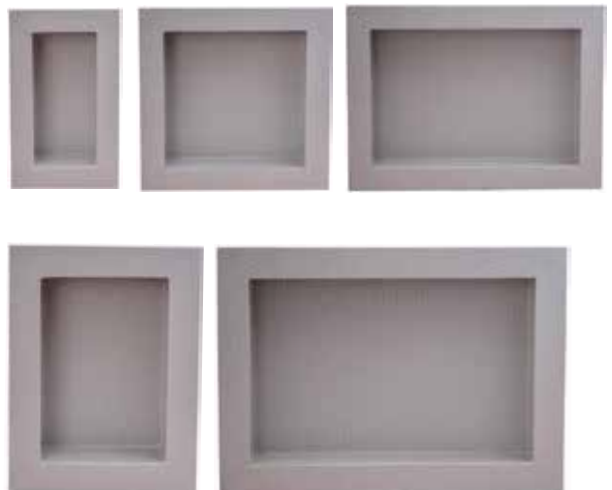

OUR RANGE OF ACCESSORIES

FOR THE INSTALLATION OF CONSTRUCTION PANELS



REINFORCEMENT TAPE

25m x 10cm fiberglass reinforcement tape used to reinforce and joint the panels together. To be used in addition to a waterproof adhesive mortar.

REF. ACC001

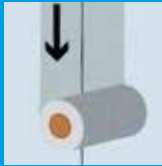

WATERPROOF TAPE

Waterproof tape 10 m x 12.5 cm, used to seal the joints between the shower tray and the walls, or between the walls. This strip is equipped with an elastomer layer and a polyester mesh layer to allow a good joint and a perfect seal. Available in rolls of 50 m.

REF. ACC002

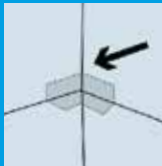

WATERPROOF CORNERS

Available in regular or inverted formats, the sealing corners provide waterproofing in addition to the strips or mats, in the most difficult to seal corners.

REF. ACC003

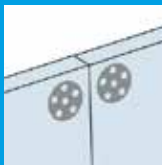

METAL FIXINGS WASHERS

Using metal washers in conjunction with screws allows for perfect anchoring system of our panels back to walls, floor and ceilings (for solid wall use masonry plugs)

REF. ACC004

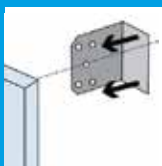

WALL ANCHORS

Wall anchors are used for panel connections to the wall and the floor. These anchors ensure that the panels stay in place and allow the construction of shelving or bath skirts

REF. ACC005

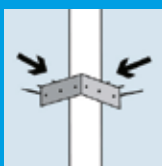

PERPENDICULAR ANCHORS

Perpendicular anchors are used for inter-panel fastening, to ensure a firm grip of the panels while the PU adhesive dries.

REF. ACC006

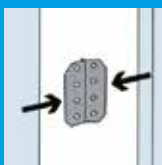

JOINT BRACKETS

The Joint Brackets are used to connect vertical panels, in order to improve overall strength. The brackets are pushed into the polystyrene and attached to the wall and are used in conjunction with PU Glue.

REF. ACC007



POLYMERIZED WATERPROOF MORTAR

Polymerized waterproof adhesive mortar which ensures the bonding and sealing of the reinforcing strips and waterproof strips. Delivered in a 5 kg bag - Available in larger packaging.

REF. ACC008



POLYURETHANE GLUE (PU)

Mono component Polyurethane Glue in cartridge, for fixing the panels together (corners or straight). Strong, fast bonding.

REF. ACC0010



SELF ADHESIVE WATERPROOF TAPE

The self-adhesive waterproof tape is equipped with a butyl underlay to ensure self-adhesion to the panels and to seal quickly.

REF. ACC011



PROFILE FOR TILE WALL 8 CM

8 cm wide U-profile for holding tileable panels for wall partitions for showers or bathroom furniture constructions - available in 5 cm on request.

REF. ACC018



marmox multiboard

Marmox Multiboard is a lightweight, high-performance tile backer board, used for waterproofing, dry-lining and thermal insulation, offering the best long-term adhesion in its class. Marmox Multiboard consists of a core of extruded polystyrene bonded between layers of fibreglass reinforced polymer concrete.

Thicknesses range from 4mm to 80mm allowing Marmox Multiboard to be used to provide a platform for tiling, a waterproof barrier, thermal insulation on walls, floors and ceilings. Multiboard is easy to cut and shape providing freedom of design and quick installation.

REF	THICKNESS (MM)	WIDTH (MM)	LENGTH (MM)	U VALUE (W/m2K)	R VALUE (m2.K/ W)	QUANTITY PER PALLET
4 MB 125	4	600 900 1200	1250	9.9	0.06	165
6 MB 125	6			7	0.12	150
10 MB 250	10		2500	3.5	0.25	215
125 MB 250	12.5			2.7	0.33	150
20 MB 250	20			1.5	0.56	106
30 MB 250	30			1	0.86	75
40 MB 250	40			0.7	1.16	60
50 MB 250	50			0.57	1.47	45
80 MB 250	80			0.5	2.33	25

Panels are available in 260cm length on special order

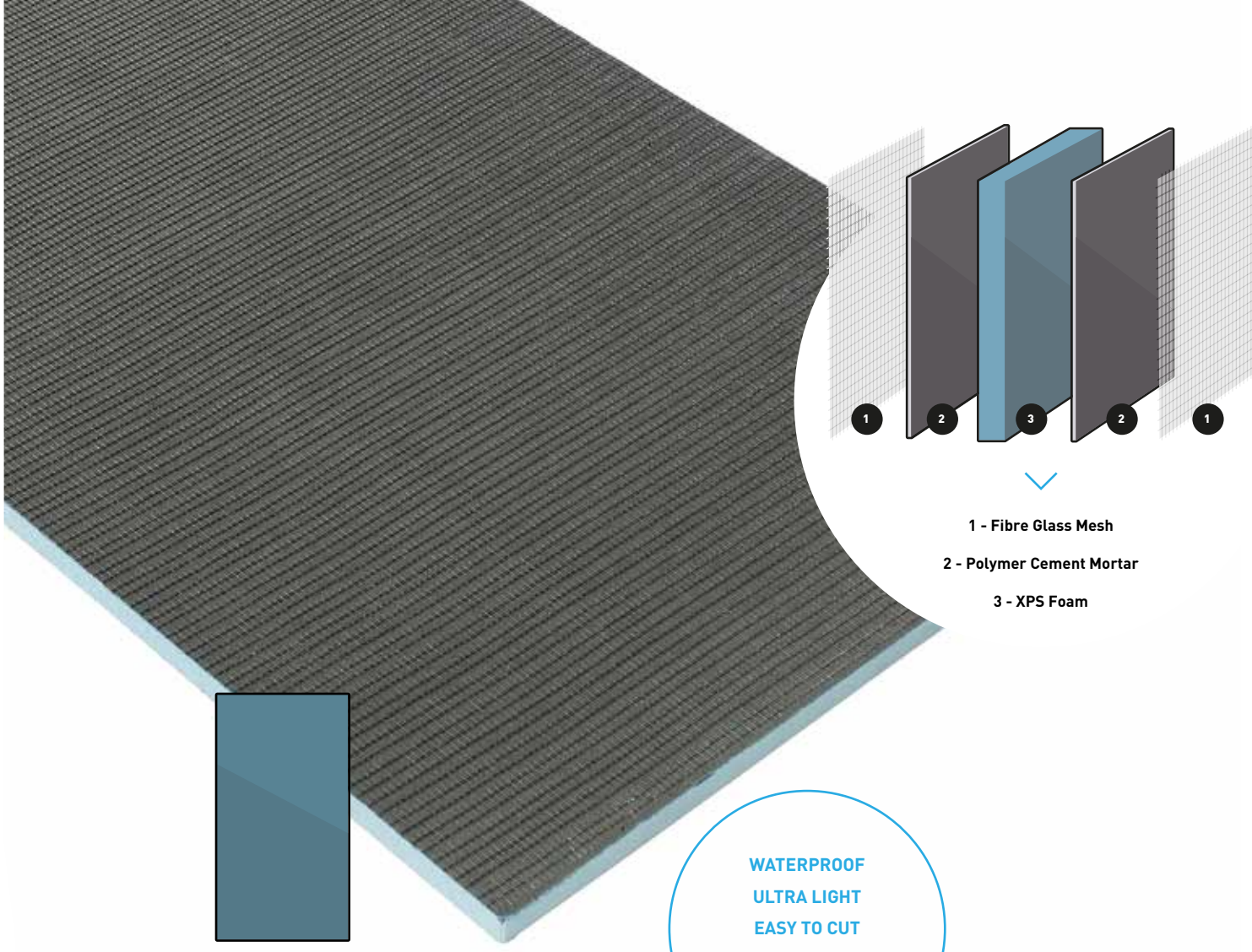

- 1 - Fibre Glass Mesh
- 2 - Polymer Cement Mortar
- 3 - XPS Foam

WATERPROOF
 ULTRA LIGHT
 EASY TO CUT
 READY TO TILE
 READY TO PLASTER

marmox ultraboard

Marmox Ultra panel offers builders and tile contractors a strong, very lightweight, waterproof, and vapor-resistant tile base for wet areas. It is an XPS foam panel manufactured with a new waterproof coating structure of synthetic polymer mortar and an alkali resistant fiber mesh. This gives it a highly rigid structure and exceptional bonding strength.

REF	THICKNESS (MM)	WIDTH (MM)	LENGTH (MM)	U VALUE (W/m2K)	R VALUE (m2.K/ W)	QUANTITY PER PALLET
4 EB 125	4	600	1250	9.9	0.06	165
6 EB 125	6		1250	7	0.12	150
10 EB 250	10	900	2500	3.5	0.25	215
125 EB 250	12.5			2.7	0.33	150
20 EB 250	20	1200	2500	1.5	0.56	106
30 EB 250	30			1	0.86	75
40 EB 250	40			0.7	1.16	60
50 EB 250	50			0.57	1.47	45
80 EB 250	80			0.5	2.33	25

Panels are available in 260cm length on special order

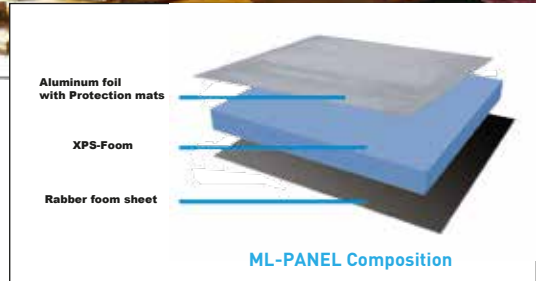
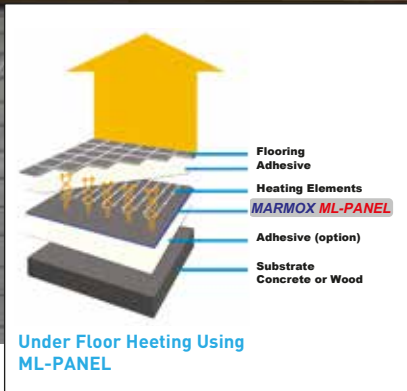

marmox ML-Panel

UNDERFLOOR HEATING PANELS

Marmox ML panels are formed of extruded polystyrene giving them their lightweight feature (1.2 Kg per Panel) while also providing additional properties such as; thermal insulation, decoupling and waterproofing. The panel features two thin layers of fibre-reinforced polymer concrete with a polyester fleece-coated layer on top of an reflective aluminium foil. The aluminium layer is designed to evenly diffuse the heat from the cables or pipes over the surface of the board. A version to reduce transmission of impact noise is available with a layer of synthetic rubber on the bottom side.

Technical Data

Panel Dimensions Length x Width (mm)	Standard 1200 x 600 other dimensions upon request
Panel total thickness (mm)	6, 10, 12.5, 20, 30, 40, 50, Other thicknesses upon request
Weight (Kg)	1-3 kg/ panel (according to thickness)
Thickness of top protective layer including Aluminum foil (mm)	0.4
Thickness of XPS core board (mm)	Panel thickness - 2.50
Thickness of rubber foam (mm)	2.5 (± 0.5)
Impact sound resistance of panel (decibels)	> 30
Thermal conductivity of XPS Foam (W/m K)	0.033
Thermal conductivity of rubber Foam (W/m K)	0.04
Thermal Resistance (m ² K / W) related to panel thicknesses :	R- Value
6 mm (1/4 ")	0.15
10 mm	0.27
12.5 mm (1/2 ")	0.35
20 mm	0.57
25 mm (1 ")	0.73
30 mm	0.87
40 mm	1.16
50 mm (2 ")	1.46
60 mm	1.76
80 mm	2.35
100 mm (4 ")	2.94
Fire Classification :	
BS 476 part 6+7	Class 0
DIN EN 13501-1	Class E



THE **tilebacker** marmox

SIMPLE INSULATING BACKER BOARD

The Tilebacker by Marmox are made from an extruded polystyrene base, topped with a layer of fiberglass mesh embedded into a polymer cement surface. They come in two thicknesses, 6mm and 10mm, and is the most cost-effective way of creating a thermal barrier between cold concrete, or wooden substrates and tiles.

The boards are ideal to be fixed directly over the top of plasterboard walls, or sheet wooden floors, creating an insulated and waterproof barrier. The Tilebacker can be used in conjunction with any size of floor or wall tile.

Mosaic tiles smaller than 50x50mm must be pre-adhered to a fiberglass or cloth mesh.

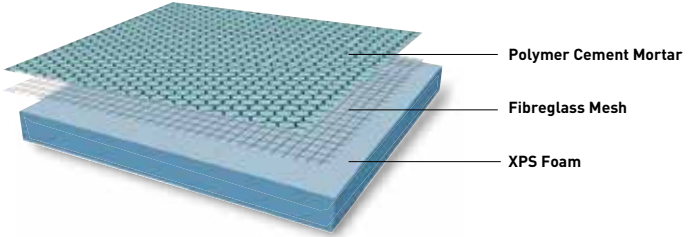

The Tilebacker Technical Properties

The Tilebacker is a manufactured to the highest quality to meet or exceed industry standards and has been independently tested in many countries.

PROPERTIES	STANDARDS	VALUES
Compressive Strength-Perpendicular To Surface	ASTM D1621 (10% Deflection)	3 kg/cm ² 30 t/m ²
Linear Coefficient of Thermal Expansion	ASTM D696	29 X 10 ⁻⁶
Thermal Conductivity	ASTM C518	0.034 W/m.K
Thermal Resistance (20mm thick)	ASTM C518	0.6 m ² K/W
Robinson Floor Test	ASTM C627	Extra Heavy Duty & High Impact Use
Water Penetration	ASTM E33109-	Passed – No Water Penetration
Flammability	EN 4766,7- EN 13501	Class 0 Class E
Surface Burning Characteristics	ANSI/NFPA No. 255 & UBC No. 81-	Flame Spread 0 Smoke Developed 70
Accelerated Aging	AC71, Section 3.5.3 - 25 Cycles	Passed – No Blistering or Delamination
Capillarity		0
Waterproof	ANSI D 4068/ANSI 118.102008-	Passed
Fungus/Bacterial Resistance	ASTM G21	Passed – No Growth
Temperature Limits		-50 to +75 °C -58 to +168 °F
Global Warming Impact		Index of 1 (No Negative Impact)
Dimensions		1,250 x 600mm
Thickness		6mm, 10mm
Colour		Foam – Blue Polymer Cement Coating – Blue
Weight		Approx 2–3 kg/m ² (Dependent Upon Thickness)
Warranty		10 Years

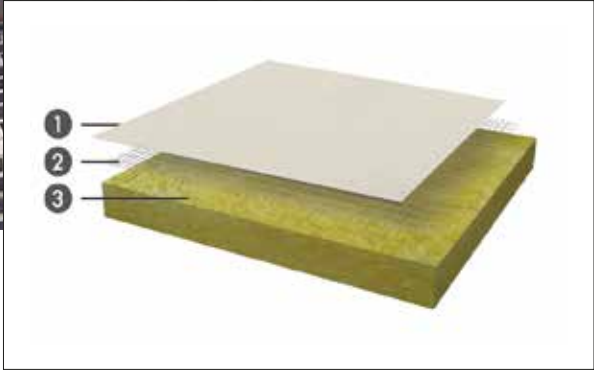

- 1 - Polymeric Cement Mortar
- 2 - Alkali-Resistant Glass Fibre Mesh
- 3 - Rockwool Density 120 kg/m³
(Higher densities upon request)

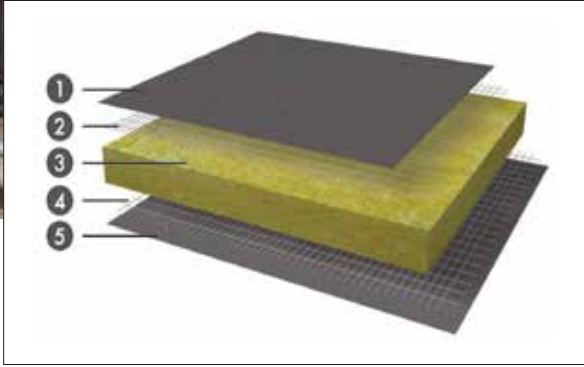

- 1 - Polymeric Cement Mortar
- 2 - Alkali-Resistant Glass Fibre Mesh
- 3 - Rockwool Density 120 kg/m³
(Higher densities upon request)
- 4 - Alkali-Resistant Glass Fibre Mesh
- 5 - Polymeric Cement Mortar

marmox[®] therm-rock[®]

SOUND & THERMAL INSULATION

Marmox ThermoRock board is a high performance, reinforced insulation board made with a non combustible mineral wool core and finished with a waterproof cement polymer mortar reinforced with alkali-resistant fiberglass mesh.

Available in a grey or white finish with a single or double sided cement polymer surface.

Thermorock Board is a perfect solution for facades, walls, suspended ceilings and steel frames, providing the highest standard in thermal, sound and A2 fire protection.

ThermoRock Board Dimensions & Weight

Product	Size mm	Thickness mm	Weight kg/m ²	
			SS	DS
ThermoRock 12.5 DS	1220 or 2440 x 600	12.5	4.5	7.5
ThermoRock 20 DS/SS	1220 or 2440 x 600	20	5.4	8.4
ThermoRock 30 DS/SS	1220 or 2440 x 600	30	6.6	9.6
ThermoRock 50 DS/SS	1220 or 2440 x 600	50	9	12
ThermoRock 100 DS/SS	1220 or 2440 x 600	100	15	18

other dimensions upon request

Stone wool TDS (Core of Mamrox ThermoRock Board)

Properties	Symbol	Unit	Tolerance	TS EN 13162	Standard
Material	MW				TS EN 13162
Density	d	kg/m ³	(+,-)% 10	120	TS EN 1602
Length	l	mm	(+,-) %2	1220	TS EN 822
Width	b	mm	(+,-) %1,5	600	TS EN 822
Determination of Squareness	Sb	mm	Max. 5mm	2 mm	TS EN 824
Determination of Flatness	Smax.	mm	Max. 3mm	1,8 mm	TS EN 825
Determination of Dimensional Stability	DS (T+)	mm	%	<1	TS EN 1604
Compressive Strength (%10 Deformation)	CS(10/Y)	kPa		≥35	TS EN 826
Determination of Tensile Strength Parallel to Faces	Σt	Kpa		≥7.5	TS EN 1607
Thickness	dN	mm	(- 3, +5)	50	TS EN 823
Declared Thermal Conductivity (10 °C)	λort	W/mK		max. 0,035	TS EN 12667
Reaction to fire				A1	TS EN 135011-
Thermal Resistance	RD	m ² K/W		1.43	TS EN 13162
Max. Usage temperature		°C		760	
Melting Point		°C		>1000	DIN 4102
Water Vapor Diffusion Resistance Coefficient	μ		1	1	TS EN 12086
Short Term Water Absorption	WP	kg/m ²	<1	<1	TS EN 1609
Long Term Water Absorption	WIP	kg/m ²	<3	<3	TS EN 12087
Certificates	CE (SERT.NO:1020-CPD-010028090) ,ISO 9001,ISO 14001,ISO 18001				,ISO 50001

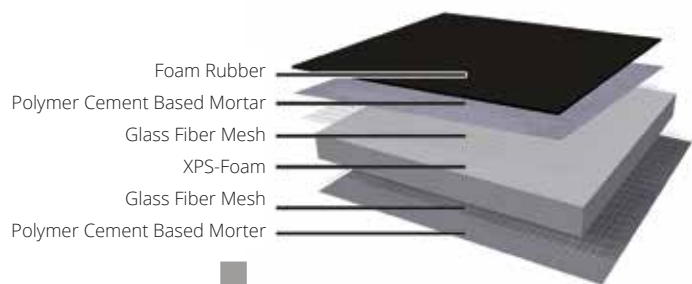

marmox soundBoard

IMPACT SOUND & THERMAL FLOOR INSULATION

Marmox SoundBoard is a tile backer board which reduces the impact noise that passes through a floor into the room below. Like Multiboard it provides a complete waterproof layer, secure decoupling, thermal insulation and low compressibility but with the added benefit of effective impact sound reduction. One side of the board is coated with a sound attenuating layer of SBR Rubber that isolates the tiled surface from the floor so that there is nothing for the sound waves to travel through. The rubber compound is natural so there is no plasticiser migration ensuring the material neither shrinks,degrades or becomes brittle. SoundBoard will reduce the level of impact noise greater than the recommended minimum of 17dB.

Technical Data

Test	8mm	12mm
Thermal conductivity	0.042 W/mk	0.04 W/mk
Thermal resistance	0.19 m ² K/W	0.30 m ² K/W
Compressive strength to EN826	300 kPa	300 kPa
DL _w Weighted impact sound reduction to ISO 140-8	28 dB	28 dB
As above (with tiled surface)	20 dB	20 dB
Dimensions	1250mm x 600mm	1250mm x 600mm
Weight	4.5kg	4.9kg



READY TO TILE

MARMOX SLOPED BOARD

IDEAL FOR WET ROOMS WITH THE DRAINAGE ON THE EDGE OF THE WALL

Marmox Sloping Boards taper from 33mm on one edge down to 10mm on the other, making them ideal for wetrooms with the drainage along the edge of the wall. Create an effective slope that can easily be extended to the whole of the room by placing boards side by side. Marmox boards are fully waterproof and comply with freeze-thaw testing requirements and suitable for external applications. Ideal for wet rooms with the drainage on the edge of the wall

Dimensions

- The board is made in just one size, 1200 x 1200mm
- The thickness of one edge is 33mm and this slopes down to 10mm at the opposite edge
- As shown above they can be combined with 20mm thick Marmox Multiboards to extend the slope indefinitely

Technical Data

	Dimensions: Surface 1200mm x 1200mm Thickness 33mm 10mm	
Thermal Conductivity	EN13164	0.034W/mK
Compressive Strength	EN862	400kPa
Coefficient of Linear Expansion	ASTM D696	8 x 10 ⁻⁶
Fire Rating	BS476	Class 0
Water Absorption	ISO 2896	<0.7%
Freeze-Thaw Resistance	ASTM 666-03	Pass

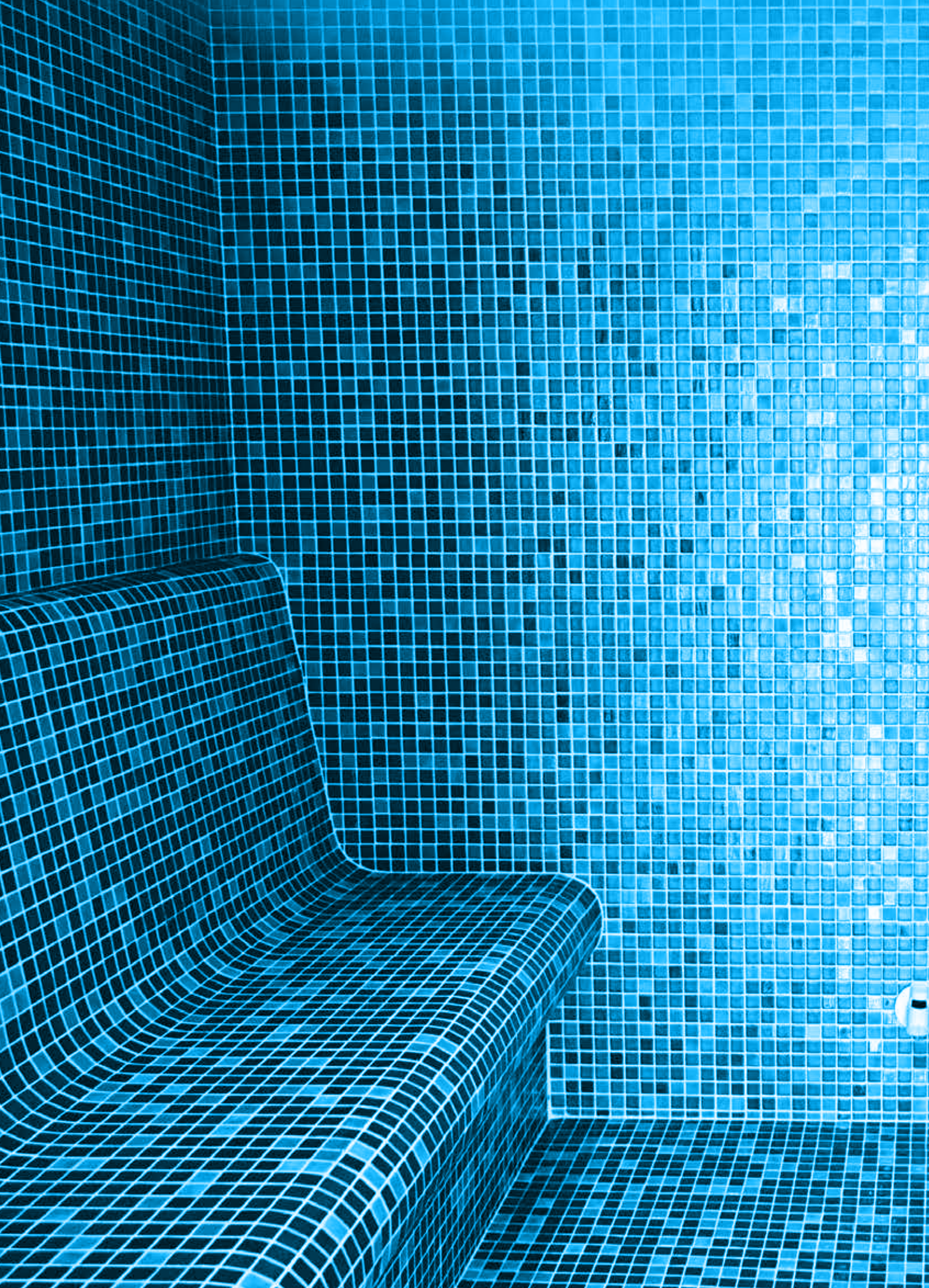

TAILORED VAPOUR BARRIER
PRODUCTS
ARCHI 3D PLANS
THREE TYPES OF BENCHES
ALL TYPES OF ROOFS

READY TO TILE
**BESPOKE
HAMMAMS**

**HAMMAMS /
WELLNESS SHOWERS**

**Trust us with your project...
We will provide you with a
hammam according to your wishes**

READY TO TILE
HAMMAM SOLUTIONS



EXAMPLE OF PLAN
Custom-made plans by an architect

READY TO TILE

HAMMAM SOLUTIONS

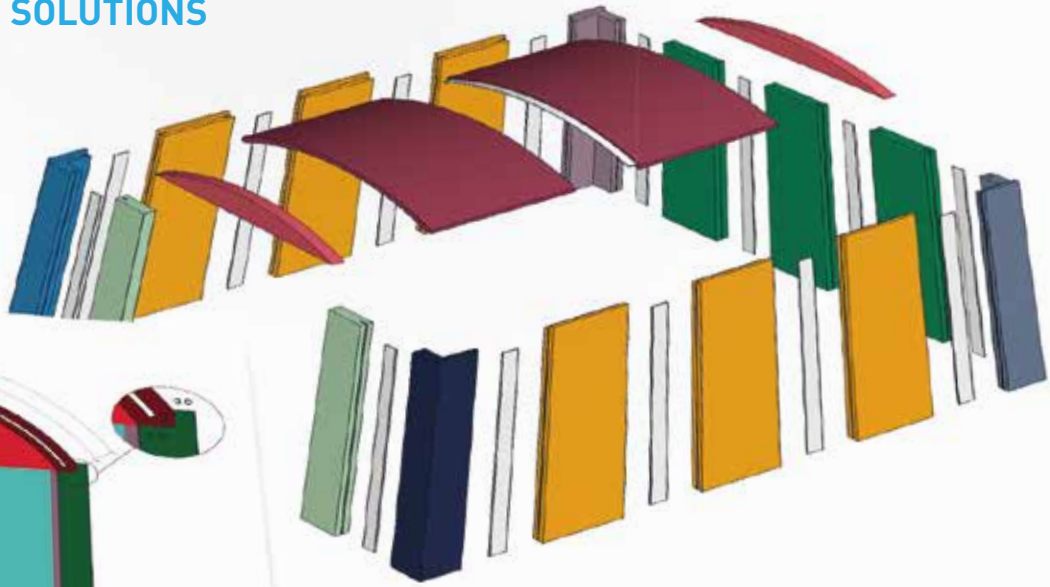

BESPOKE HAMMAMS

In order to meet the growing demand for comfort required for professional or domestic hammams, we offer a tailor-made hammam concept that will suit everyone's desires, along three axes:

- Product quality with the Marmox Board standard finish and vapour barrier options.
- All types of benches, all types of roofs, all types of tileable shower trays
- Custom plans with 3D views to propose the concept to your customers and facilitate installation for installers.
- The whole range of accessories required for hammams:
 - Door
 - Generator
 - Lighting or Starry Sky
 - Aromatherapy
 - Fan
 - ...

MARMOX BENCHES

Marmox offers three types of benches:
a square bench seat for cubic shapes and architecture,
a standard rounded bench seat without backrest and a
rounded bench seat with backrest for more comfort.

All our Marmox benches are made to the nearest centimeter and can also be cut on site if necessary. The Marmox benches are all equipped with a recess in the lower part for the passage of cables and pipes.

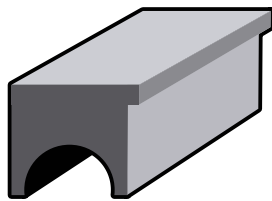

SQUARE

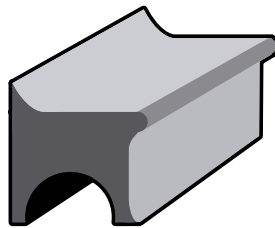

REGULAR

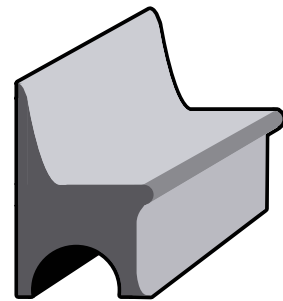

CHAIR

REF	LENGTH	TOTAL WIDTH (MM)	ENCROACHMENT WIDTH (MM)	TOTAL HEIGHT (MM)	SEAT HEIGHT (MM)	SLOPE
SQUARE		500	450	500	-	
REGULAR	To Measure	511	425	475	410	%1
CHAIR		561	430	890	440	

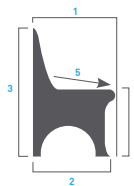

BESPOKE MARMOX BENCHES CAN BE MADE

ROOFS

Marmox offers all types of roofs, pre-assembled, stiffened, ready-to-install:
Flat roof, pitched roof, tunnel roof, dome roof...

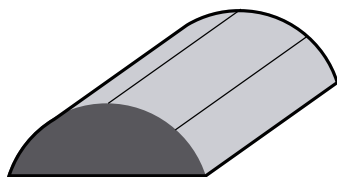

VAULT - TUNNEL

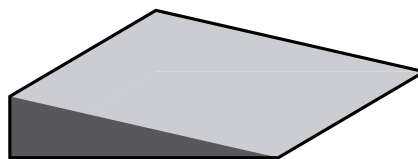

MONO-SLOPE

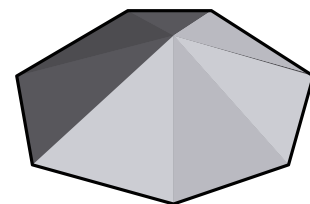

DOME

WALLS AND PLANS

Marmox adapts the panels in width and height to provide you with a tailor-made hammam. All our panels are tongue and grooved to offer a better structural integrity. We offer vapour barrier finishes on request.

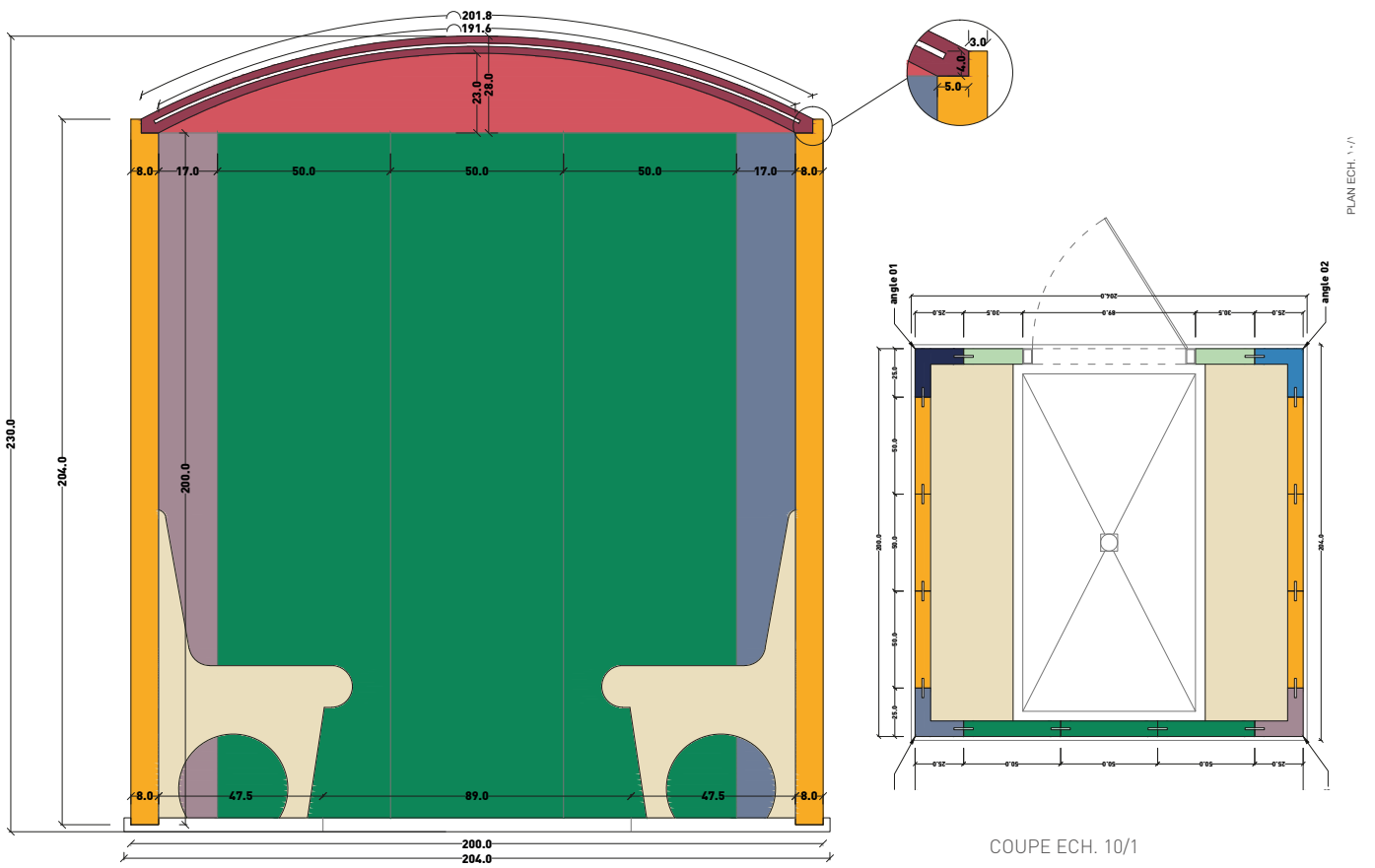
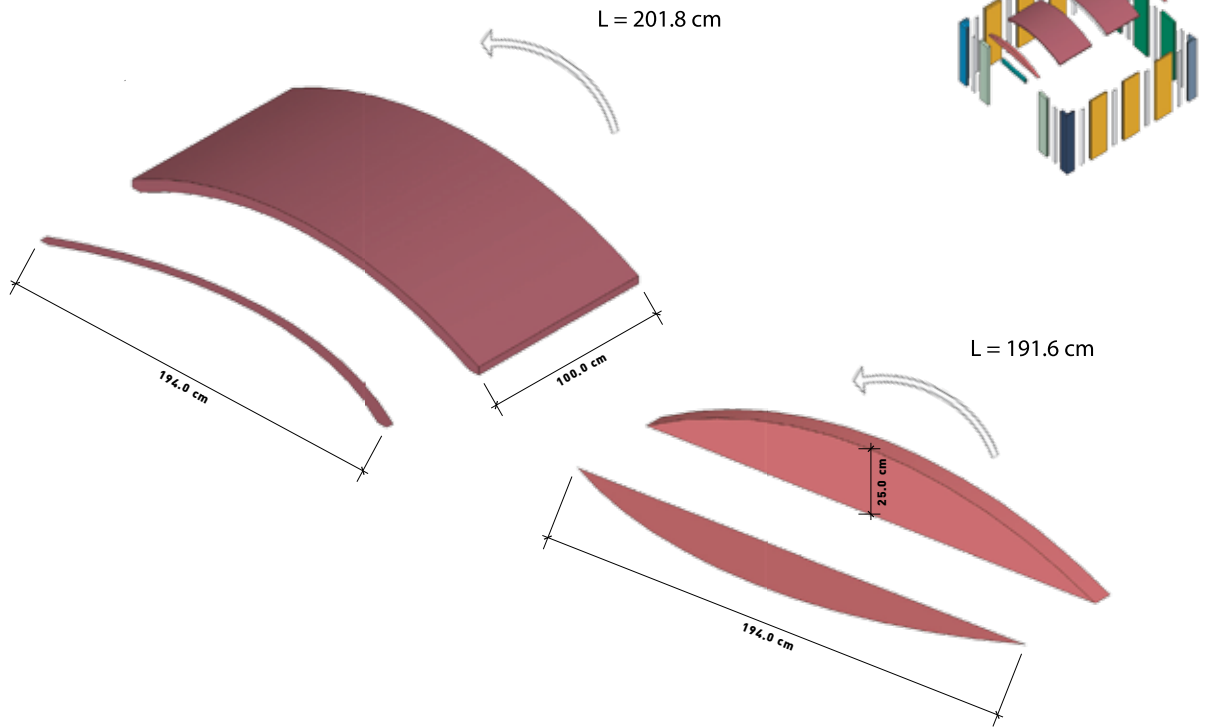

EXAMPLE OF PLAN
Custom-made plans by an architect

MINILAY FLOOR DRAIN SOLUTIONS



Minilay provides the flexibility and freedom to transform any concrete floor into a tileable wetroom floor



minilay^{marmox}
Floor Drain Solutions

MINILAY FLOOR DRAIN SOLUTIONS



Minilay Square Kit with Slimline Trap



Minilay Square Kit with 360° Swivel Trap



Minilay Channel Kit with Slimline Trap



Minilay Channel Kit with 360° Swivel Trap

Minilays the solution to creating a sloping wetroom floor

A Marmox Minilay provides the flexibility and freedom to transform any concrete floor into a tileable wet-room floor. Marmox Minilays come with a choice of 600mm long stainless steel Channel grates or with a 120 x 120mm stainless steel square grate.

Both of these drain types are also offered with a standard 360° Swivel Trap with a flexible outlet (allowing for horizontal or vertical drainage) or the Slimline Trap which is just 6cm deep.



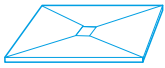

FLOOR DRAIN SOLUTIONS
SQUARE OUTLET

minilay marmox
Floor Drain Solutions



**SWIVEL TRAP
HORIZONTAL / VERTICAL**



WATERPROOF MAT

**ADJUSTABLE FRAME
ACCORDING TO TILE
THICKNESS**

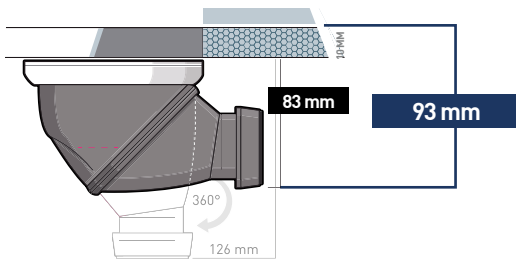

**INNOVATION
SWIVEL TRAP
WATERPROOFING
SYSTEM
GRID HEIGHT
ADJUSTMENT**

**JAMES
FLOOR DRAIN**

A walk-in floor drain, with an integrated waterproof mat, utilizing a 360° swivel trap which enables connection in all directions (vertical, horizontal, intermediary).



**SQUARE GRID
PROVIDED**

SQUARE GRID (STANDARD)



OPTIONAL GRIDS

SQUARE GRID 2



ROUND GRID



DIAGONAL GRID

REF	DESCRIPTION	UNDERLAY SIZE (MM)	GRID WIDTH (MM)	GRID LENGTH (MM)	UNDERLAY THICKNESS (MM)
RC 20 ACIER	360° FLOOR DRAIN	200 X 200	115	115	10

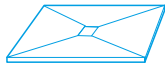

FLOOR DRAIN SOLUTIONS
SQUARE OUTLET

minilay marmox
Floor Drain Solutions



SWIVEL TRAP

ADJUSTABLE FRAME
ACCORDING TO TILE
THICKNESS

WATERPROOF MAT

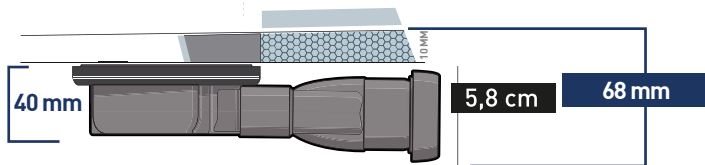

**INNOVATION
SLIM TRAP
WATERPROOFING
SYSTEM
GRID HEIGHT
ADJUSTMENT**

SLIM FLOOR DRAIN

A walk-in floor drain, with an integrated waterproof mat, utilizing an Ultra-Low-Profile trap with a maximum displacement of 6.8 cm



SQUARE GRID PROVIDED

SQUARE GRID (STANDARD)

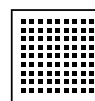

OPTIONAL GRIDS

SQUARE GRID 2



ROUND GRID



DIAGONAL GRID

REF	DESCRIPTION	UNDERLAY SIZE (MM)	GRID WIDTH (MM)	GRID LENGTH (MM)	UNDERLAY THICKNESS (MM)
RC 20 SLIM	ULTRA-LOW-PROFILE FLOOR DRAIN	200 X 200	115	115	10

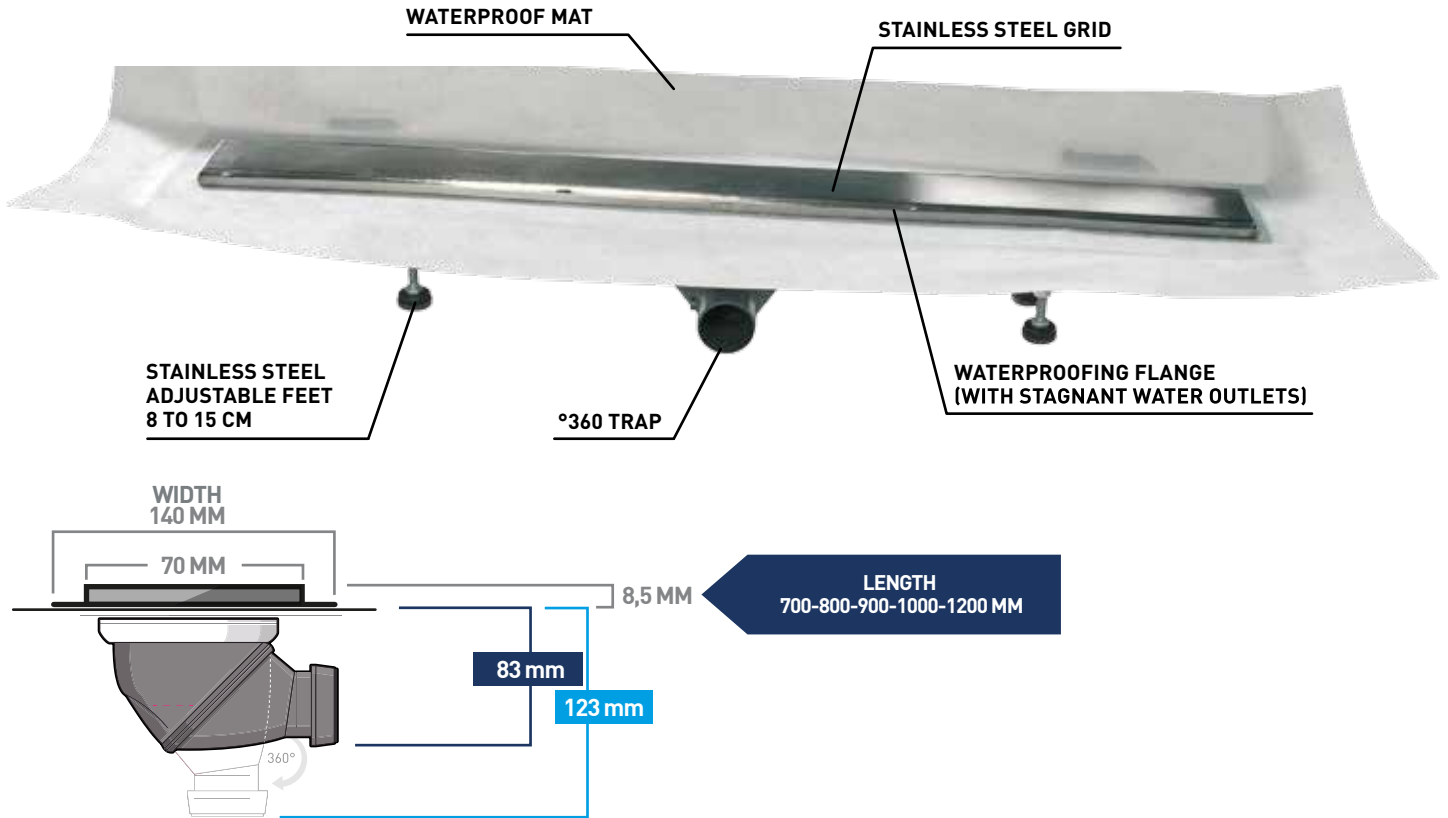

VERSOPRIMO SHOWER CHANNEL

Marmox offers professionals a traditional range of walk-in solutions. The channels are manufactured entirely in Stainless Steel and enable the installation of a custom-made walk-in shower using a screed. Available in lengths from 70 to 120 cm, the channels will allow you to follow the trend of shower channels at a lower cost. All Channels are delivered with 4 adjustable feet, a waterproof flap to ensure the connection to the screed and are designed with a drainage system for lost water infiltrated under tiles. Marmox offers with these channels the °360 Wirquin James trap which will allow you an easy connection with a significant flowrate.



REF	TOTAL LENGTH (MM)	GRID LENGTH (MM)	TOTAL WIDTH (MM)	GRID WIDTH (MM)	DISPLACEMENT UNDER CHANNEL - HORIZONTAL VERSION (MM)	DISPLACEMENT UNDER CHANNEL - VERTICAL VERSION (MM)
LD 70	750	700	140	70	83	123
LD 80	850	800				
LD 90	950	900				
LD 100	1050	1000				
LD 120	1250	1200				

- Flow rate in Litres per minute > 40 Litres
- Diameter of outlet - 40 mm
- Type of outlet - Glue or Screwable
- Height of Grid Frame - 8mm

**BESPOKE LENGTHS
AVAILABLE ON
REQUEST**

STANDARD GRID PROVIDED

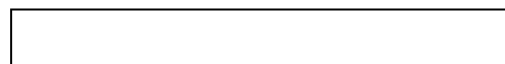

FULL GRID (STANDARD)

OPTIONAL GRIDS

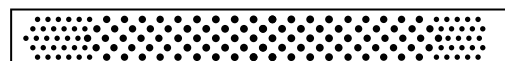

ROUND LINE GRID

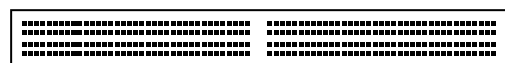

SQUARE LINE GRID

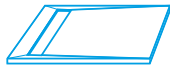

FLOOR DRAIN SOLUTIONS
CHANNEL OUTLET

minilay marmox
Floor Drain Solutions

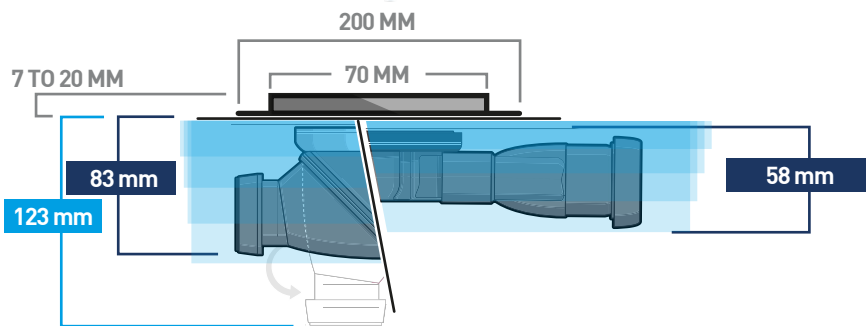
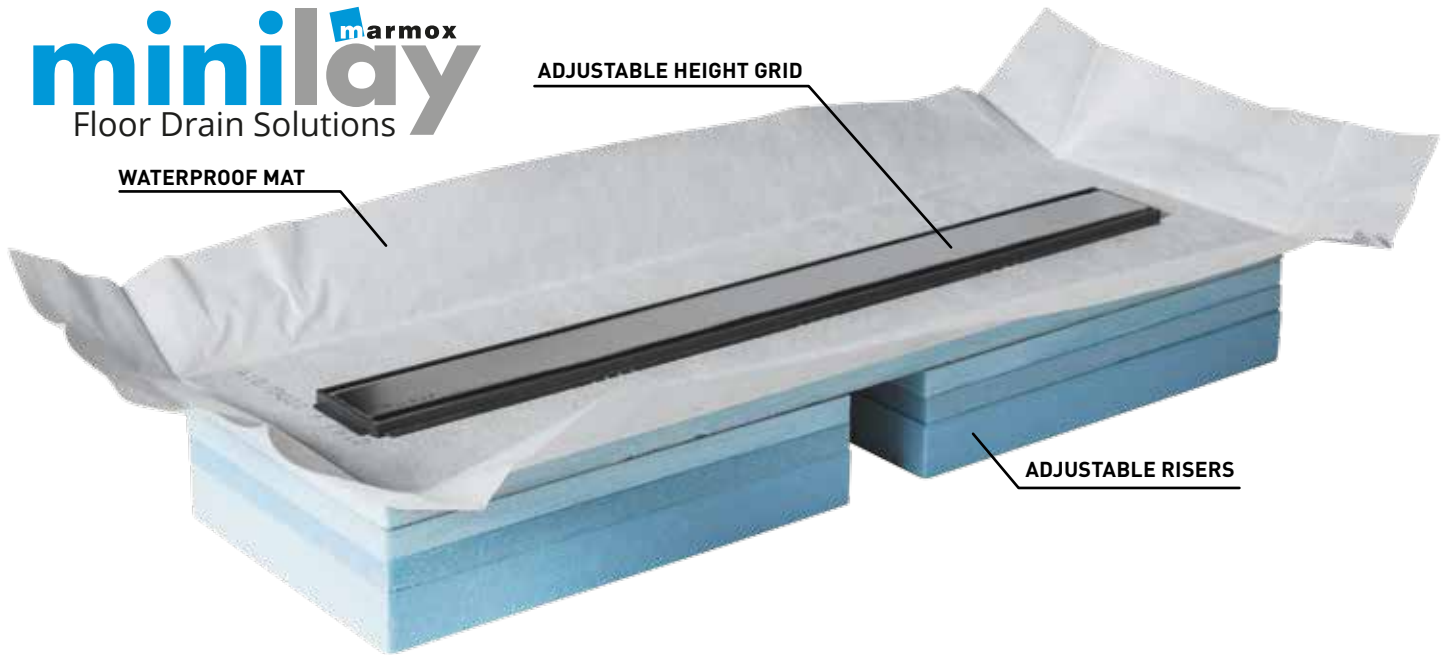

MAESTRO NEW GENERATION SHOWER CHANNEL

Discover Marmox new system, largely inspired by the walk-in floor drain, that meets a long-term trend: Channels...

Designed with a mini-underlay on the principle of a shower tray, the channel is mounted on a waterproof mat, offered with a stainless-steel grid, but also compatible with colour grids or tileable grids. The grids are adjustable to the height of the tiling by a system of clips. The walk-in shower channel rests on polystyrene risers which will ensure stability over time and which are adjustable according to the desired height. The channel is available in two versions: JAMES trap with vertical / horizontal swivelling outlet or SLIM (ultra-low profile) which makes it one of the lowest profile channels on the market.

REF	DESCRIPTION	TOTAL LENGTH (MM)	GRID LENGTH (MM)	TOTAL WIDTH (MM)	GRID WIDTH (MM)	DISPLACEMENT UNDER CHANNEL (MM)	WEIGHT (KG)	QUANTITY PER BOX
LD 70 JAMES	Floor Drain channel with °360 trap	750	700	250	70	83	3	1 Piece
LD 70 SLIM	Floor Drain channel with slim ultra-low-profile trap	750	700	250	70	45	3	1 Piece



STANDARD GRID PROVIDED

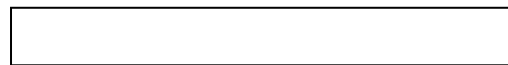

FULL GRID (STANDARD)

OPTIONAL GRIDS

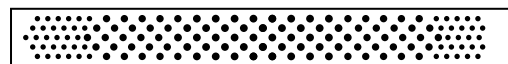

ROUND LINE GRID

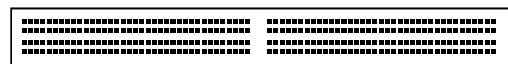

SQUARE LINE GRID

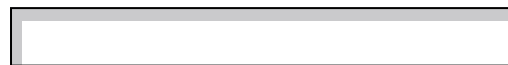

TILEABLE GRID



HYGIENIC
ECONOMIC
ACCESSIBLE TO EVERYONE
EASY TO INSTALL
CUSTOMIZABLE
AESTHETIC

marmox 360
showerlay
TILEABLE SHOWERTRAY SOLUTIONS



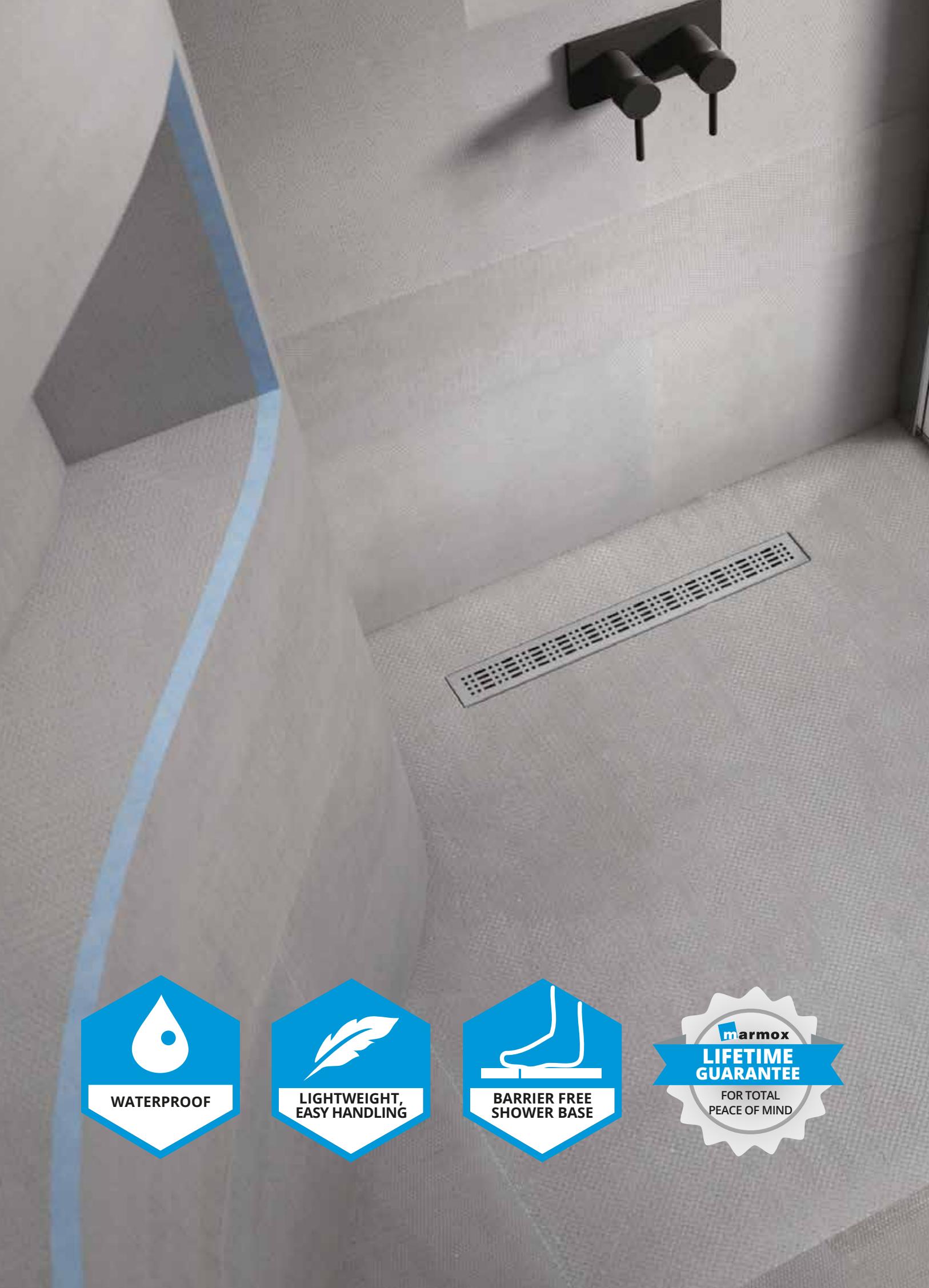

marmox showerlay³⁶⁰

TILEABLE SHOWERTRAY SOLUTIONS

Marmox provides you with a range full of innovations and professional products for making a long-lasting walk-in shower.

Designed with materials similar to tileable panels, our shower trays are made of an alloy of extruded polystyrene foam and reinforced on each side of the shower tray with fiberglass mesh and a layer of polymerized cement mortar. Our shower trays are then equipped with an integrated waterproof mat that protrudes 10 cm on each side to offer an economical and secure installation.

The different types of tileable shower trays:

SQUARE GRID SOLUTIONS

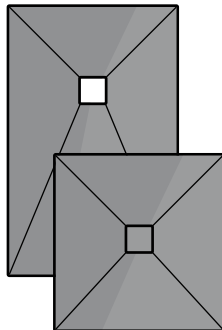

FLATBOARD
SLIMBOARD
COMPACT BOARD
FORMAT : SQUARE OR RECTANGULAR

CHANNEL SOLUTIONS

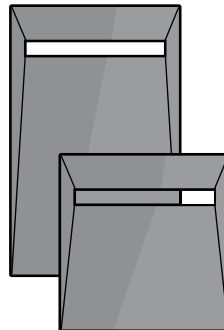

LINEBOARD
COMPACT LINE BOARD
FORMAT : SQUARE OR RECTANGULAR

MONOSLOPE CHANNEL SOLUTIONS

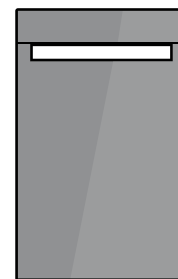

MONOBOARD
FORMAT : RECTANGULAR

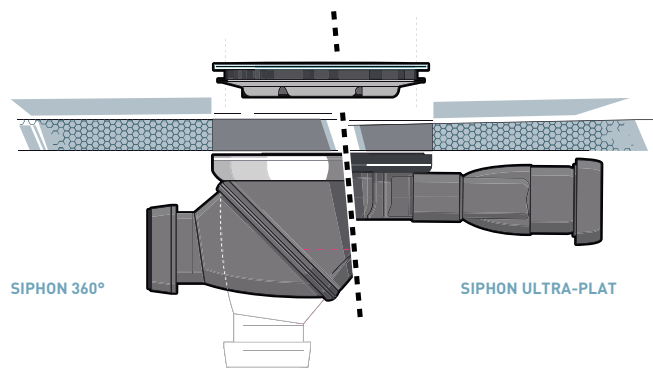

DESCRIPTION	TEST	RESULT
Compressive Force	(ASTM C579)	0.5 N/mm ²
Fire Characteristics	EN 1-13501	CLASS E
Density		0.02 ± 36 kg/m ³
Grip	BS EN 1384	0.3 N/mm ²
Water absorption in immersion	DIN 53428	%0.02 byVol
Water absorption (capillary)	DIN 53428	NIL

Water Seal	50mm in accordance with EN274 Standard
Displacement under Tray	83mm (Horizontal Outlet) - James
	123mm (Vertical Outlet) - James
	58mm - Slim
Flowrate	Approx 40 Litres per minute
Outlet Diameter	40mm
Grid Size	115 x 115mm
Channel Size	700mm

Technical features of standard trays

marmox
showerlay³⁶⁰
 TILEABLE SHOWERTRAY SOLUTIONS
WATERPROOF MAT

INNOVATION

The trays are equipped with a waterproof mat that is crimped onto the waste and bonded to the tray. The mat provides integration to the walls and creates a peripheral seal, ensuring a watertight installation

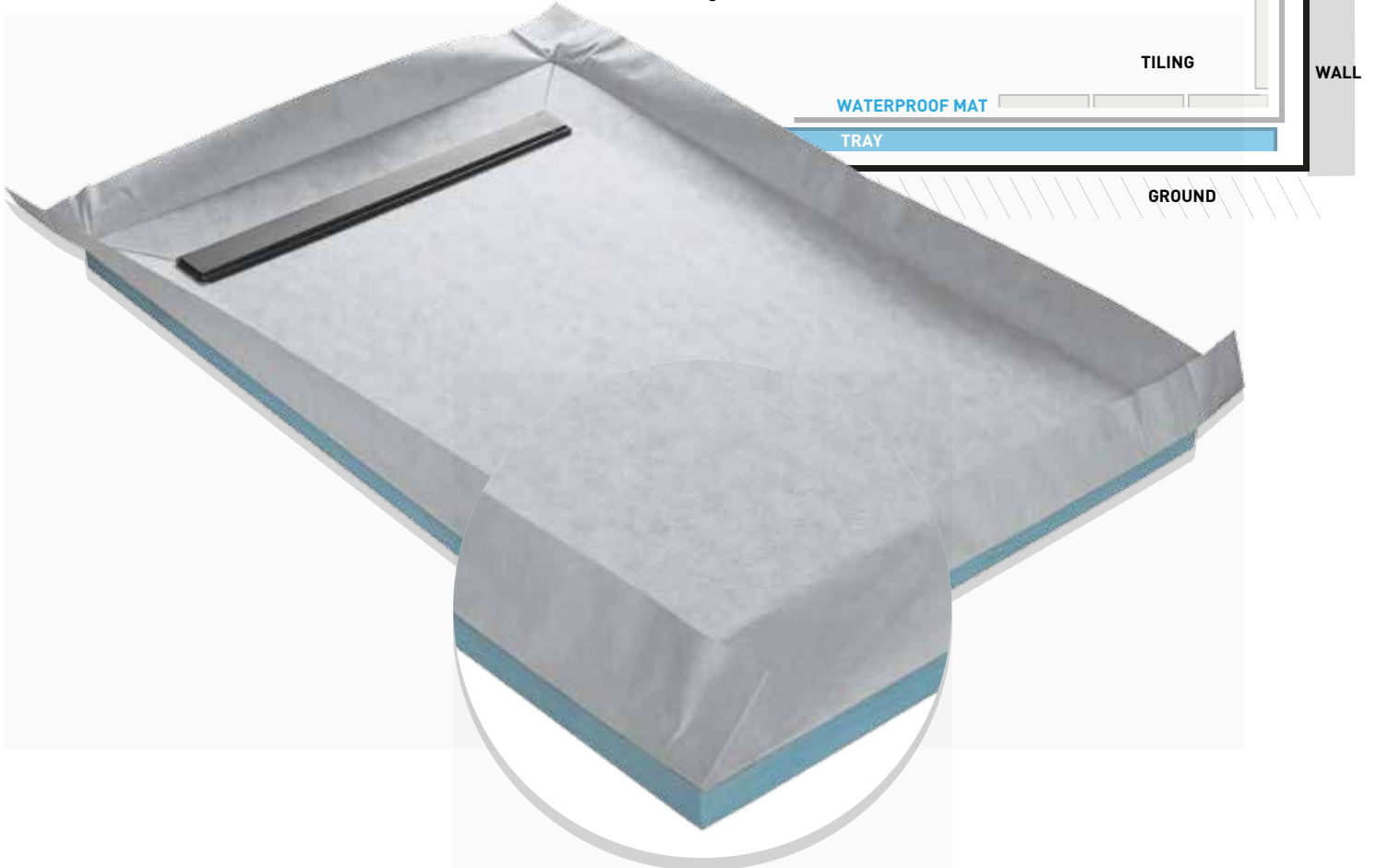

PERFORATION RESISTANCE

The mortar and fibre reinforce the surface under the mat to provide a very high perforation resistance by distributing the weight over a larger surface. This guarantees the installation of mosaics as well as the resistance of the product during the tiling installation

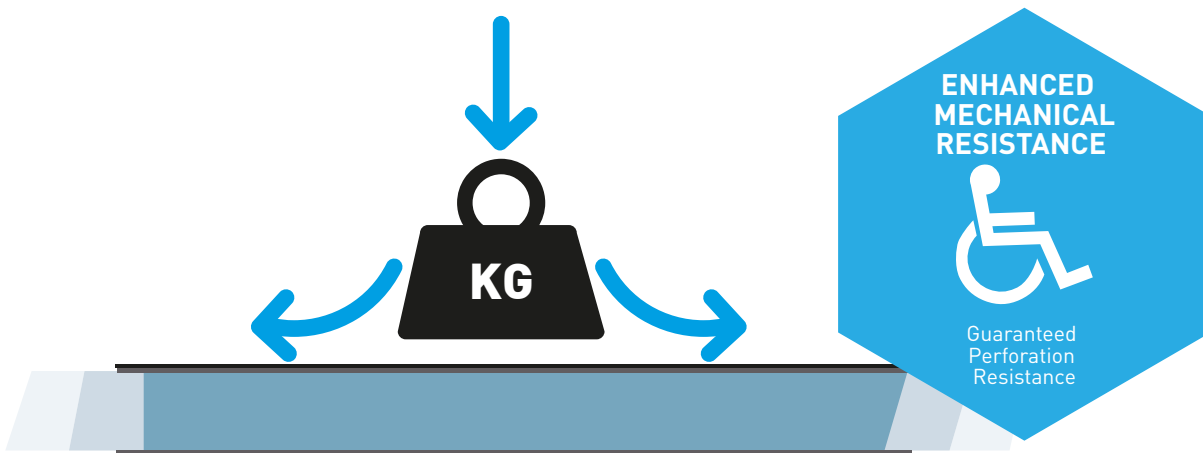

marmox showerlay³⁶⁰

TILEABLE SHOWERTRAY SOLUTIONS

OUTLETS TWO PRODUCTS TO CHOOSE FROM

The traps are all available in 40mm diameter (glue or screwable). The traps also all provide a drainage system for infiltrated water under tiles and a grid raising system to adapt to all tiles. 360 ° or ultra-low profile, the assurance of finding the ideal trap for your site constraints.

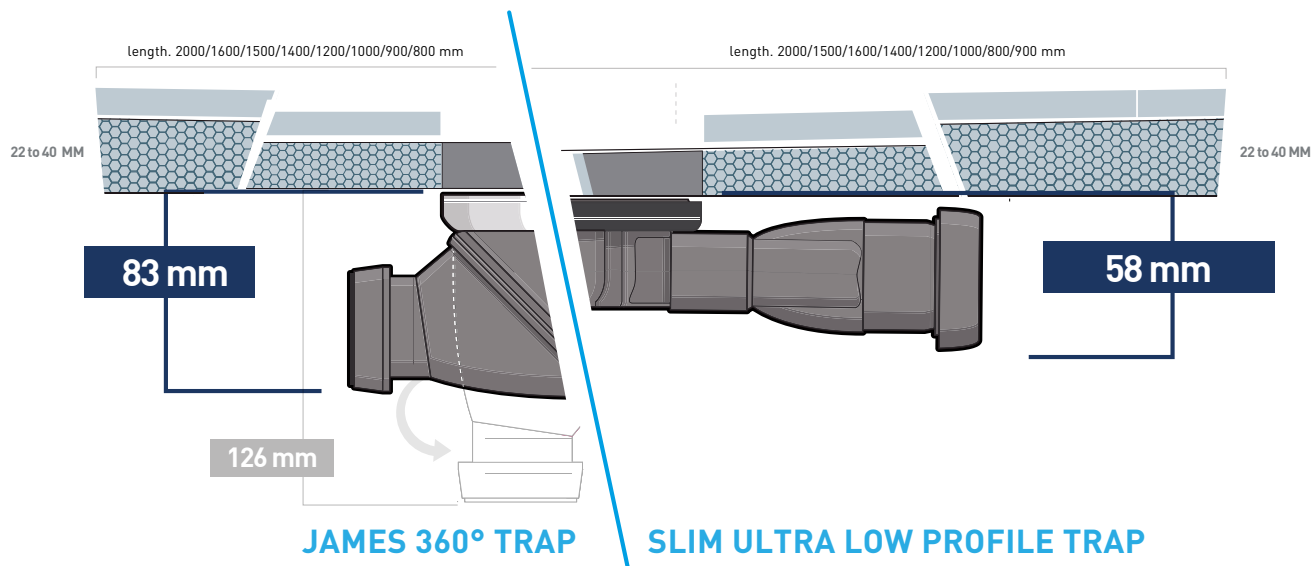

OUR RANGE OF ACCESSORIES

FOR THE INSTALLATION OF CONSTRUCTION PANELS



WATERPROOF TAPE

Waterproof tape 10 m x 12.5 cm, used to seal the joints between the shower tray and the walls, or between the walls. This strip is equipped with an elastomer layer and a polyester mesh layer to allow a good joint and a perfect seal. Available in rolls of 50 m. REF. ACC002



WATERPROOF CORNERS

Available in regular or inverted formats, the sealing corners provide waterproofing in addition to the strips or mats, in the most difficult to seal corners.

REF. ACC003



POLYMERIZED WATERPROOF MORTAR

Polymerized waterproof adhesive mortar which ensures the bonding and sealing of the reinforcing strips and waterproof strips. Delivered in a 5 kg bag - Available in larger packaging.

REF. ACC008



UNIVERSAL SHOWER TRAY RISER

Universal 200 x 120 cm hybrid riser (3+5 cm). Designed with a sheet in 5cm and one in 3cm, this riser will adapt to all sizes of shower trays and all depths of traps.

REF. ACC016

GRIDS

SQUARE OUTLET

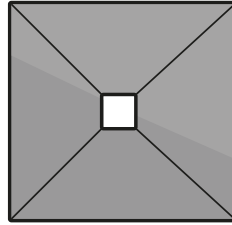

This year's square grid and timeless design is available in stainless steel as well as in trendy colours such as matt black, white or slate grey. Breaking with the traditional stainless-steel finish, these colours will fit elegantly into your bathroom and blend with all the tiles. Also available in colour on The Diagonal, Square 2 and Round models.

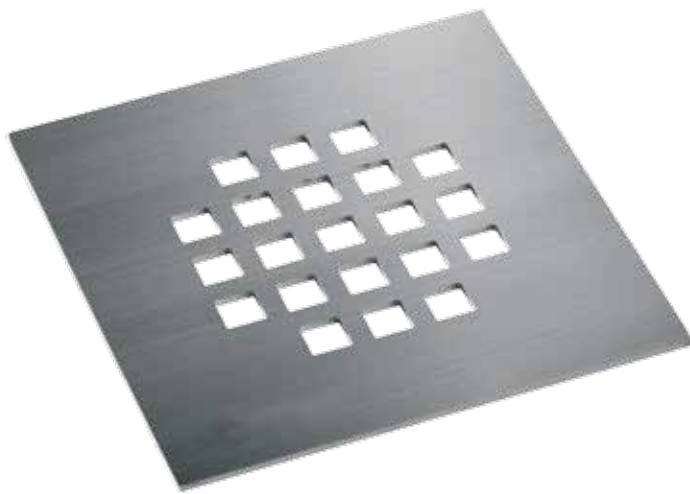

STAINLESS STEEL GRID
(DELIVERED STANDARD WITH OUR PRODUCTS)

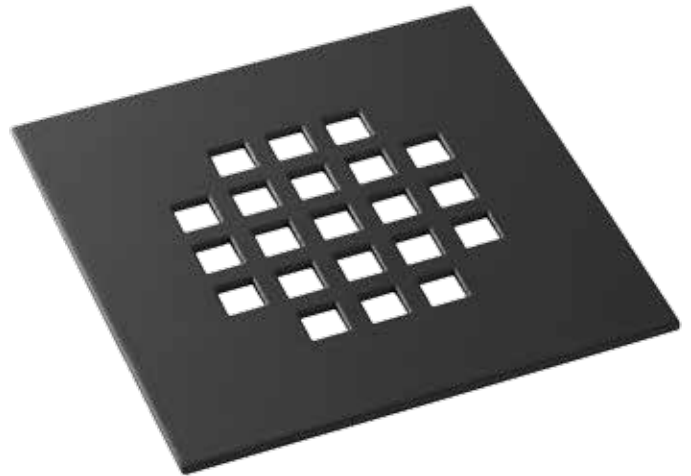

MATT BLACK GRID RAL 9005



SLATE GREY GRID RAL 7015

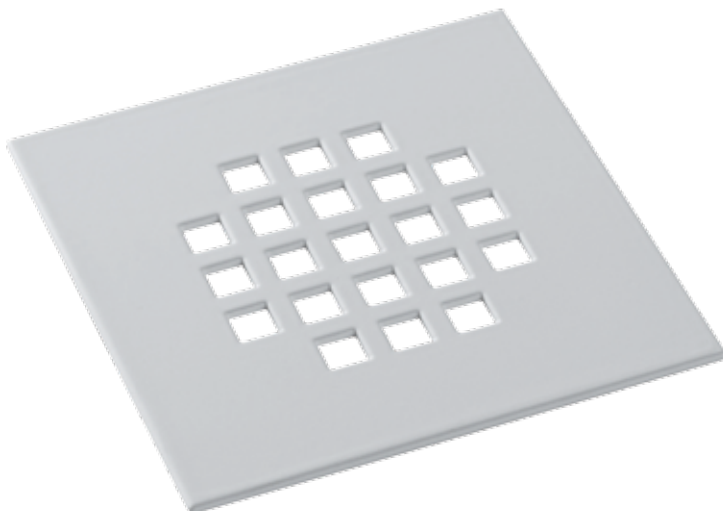

WHITE GRID RAL 9010



STANDARD GRID PROVIDED

SQUARE GRID (STANDARD)



OPTIONAL GRIDS

SQUARE GRID 2



ROUND GRID



DIAGONAL GRID

GRIDS

CHANNEL OUTLET

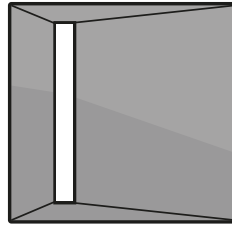

Like the square grids, our models of channel grids are offered to you this year in trendy colours to enhance the range and meet all finishing requirements.

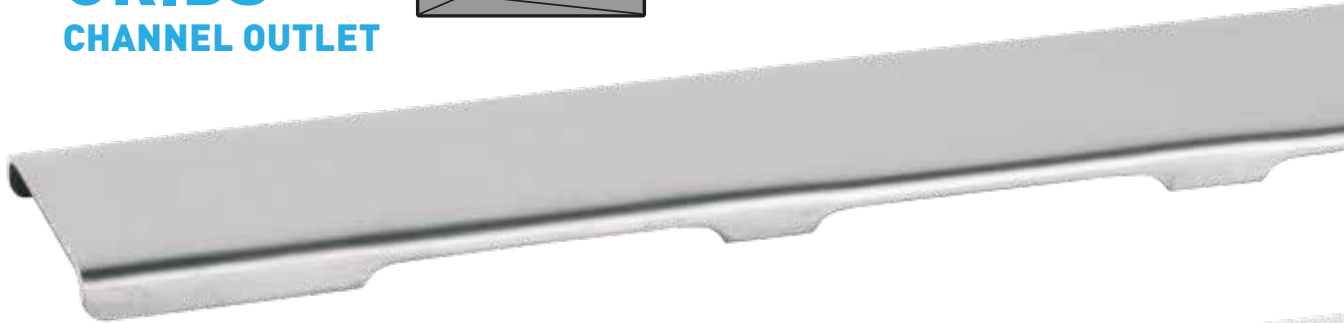

STAINLESS STEEL GRID
(DELIVERED STANDARD WITH OUR PRODUCTS)



WHITE GRID RAL 9010



MATT BLACK GRID RAL 9005



SLATE GREY GRID RAL 7015

STANDARD GRID PROVIDED



FULL GRID (STANDARD)

OPTIONAL GRIDS

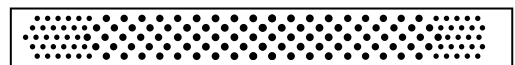

ROUND LINE GRID

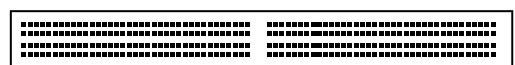

SQUARE LINE GRID

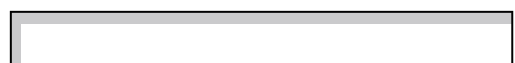

TILEABLE GRID

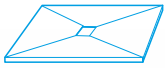

TILEABLE SHOWER TRAY SOLUTIONS
SQUARE OUTLET

marmox
showerlay³⁶⁰
TILEABLE SHOWERTRAY SOLUTIONS

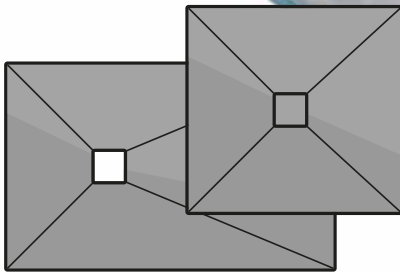

FLATBOARD

TILEABLE SHOWER TRAY

Standard tileable tray with 360 ° or ultra-low-profile trap and pre-assembled waterproof mat

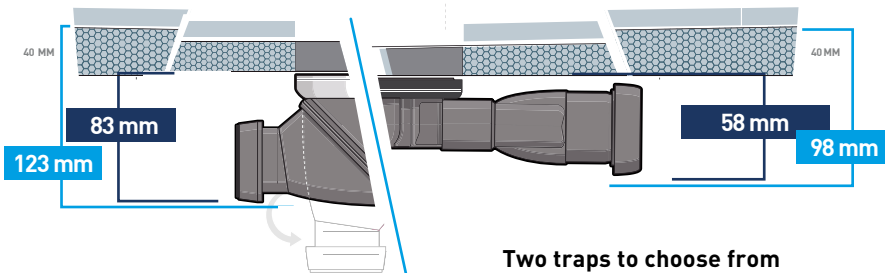

JAMES 360° TRAP

SLIM ULTRA LOW-PROFILE TRAP

Two traps to choose from

LIGHT
EXTRA LOW PROFILE
CAN BE CUT
INTEGRATED
WATERPROOF MAT
COMPATIBLE WITH ALL
TILES
°360 WASTE

REF	DESCRIPTION	FORMAT	LENGTH (MM)	WIDTH (MM)	THICKNESS (MM)	POSITION OF TRAP
RC 80 FLAT	TILEABLE SHOWER TRAY 800X800		800	800	40	400/400
RC 90 FLAT	TILEABLE SHOWER TRAY 900X900		900	900	40	450/450
RC 100 FLAT	TILEABLE SHOWER TRAY 1000X1000		1000	1000	40	500/500
RC 120 FLAT	TILEABLE SHOWER TRAY 1200X1200	CENTRE	1200	1200	40	600/600
RC 150 FLAT	TILEABLE SHOWER TRAY 1500X1500		1500	1500	40	750/750
RC 12090 CENTRE	TILEABLE SHOWER TRAY 1200X900		1200	900	40	600/450
RC 18590 CENTRE	TILEABLE SHOWER TRAY 1850X900		1850	900	40	925/450
RC 12090 FLAT	TILEABLE SHOWER TRAY 1200X900		1200	900	40	320/450
RC 14090 FLAT	TILEABLE SHOWER TRAY 1400X900		1400	900	40	320/450
RC 16090 FLAT	TILEABLE SHOWER TRAY 1600X900	OFFSET BATH FORMAT	1600	900	40	320/450
RC 150100 FLAT	TILEABLE SHOWER TRAY 1500X1000		1500	1000	40	320/500
RC 18590 FLAT	TILEABLE SHOWER TRAY 1850X900		1850	900	40	320/450
RC 200100 FLAT	TILEABLE SHOWER TRAY 2000X1000		2000	1000	40	320/500



STANDARD GRID PROVIDED

SQUARE GRID (STANDARD)



OPTIONAL GRIDS

SQUARE GRID 2



ROUND GRID



DIAGONAL GRID



TILEABLE SHOWER TRAY SOLUTIONS
SQUARE OUTLET

marmox
showerlay³⁶⁰
TILEABLE SHOWERTRAY SOLUTIONS

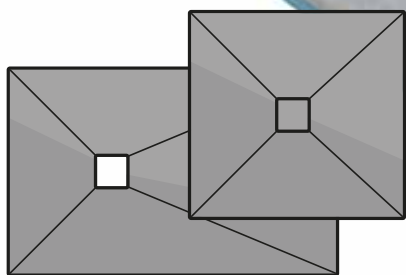

SLIMBOARD

TILEABLE SHOWER TRAY

22 mm ultra-low profile tileable tray with 40 mm ultra-low-profile trap and integrated waterproof mat.
Special space saving solution for renovations

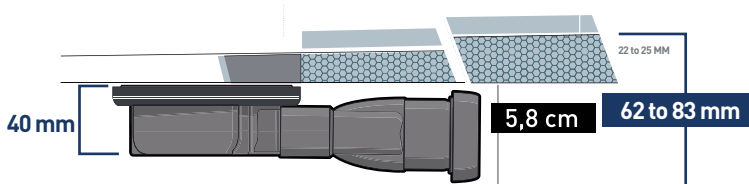

INNOVATION
ULTRA LOW-PROFILE
LIGHT
CAN BE CUT
INTEGRATED
WATERPROOF MAT
COMPATIBLE WITH ALL
TILES



STANDARD GRID PROVIDED

SQUARE GRID (STANDARD)



OPTIONAL GRIDS

SQUARE GRID 2



ROUND GRID



DIAGONAL GRID

REF	DESCRIPTION	FORMAT	LENGTH (MM)	WIDTH (MM)	THICKNESS (MM)	POSITION OF TRAP
RC 90 SLIM	TILEABLE SHOWER TRAY ULTRA-LOW-PROFILE 900X900		900	900	22	400/400
RC 100 SLIM	TILEABLE SHOWER TRAY ULTRA-LOW-PROFILE 1000X1000	CENTRE	1000	1000	22	450/450
RC 120 SLIM	TILEABLE SHOWER TRAY ULTRA-LOW-PROFILE 1200X1200		1200	1200	22	500/500
RC 12090 SLIM	TILEABLE SHOWER TRAY ULTRA-LOW-PROFILE 1200X900		1200	900	22	600/600
RC 150100 SLIM	TILEABLE SHOWER TRAY ULTRA-LOW-PROFILE 1500X1000	OFFSET BATH FORMAT	1500	1000	25	320/500
RC 18590 SLIM	TILEABLE SHOWER TRAY ULTRA-LOW-PROFILE 1850X900		1850	900	25	320/450

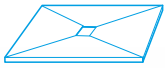

TILEABLE SHOWER TRAY SOLUTIONS
SQUARE OUTLET

marmox
showerlay³⁶⁰
TILEABLE SHOWERTRAY SOLUTIONS

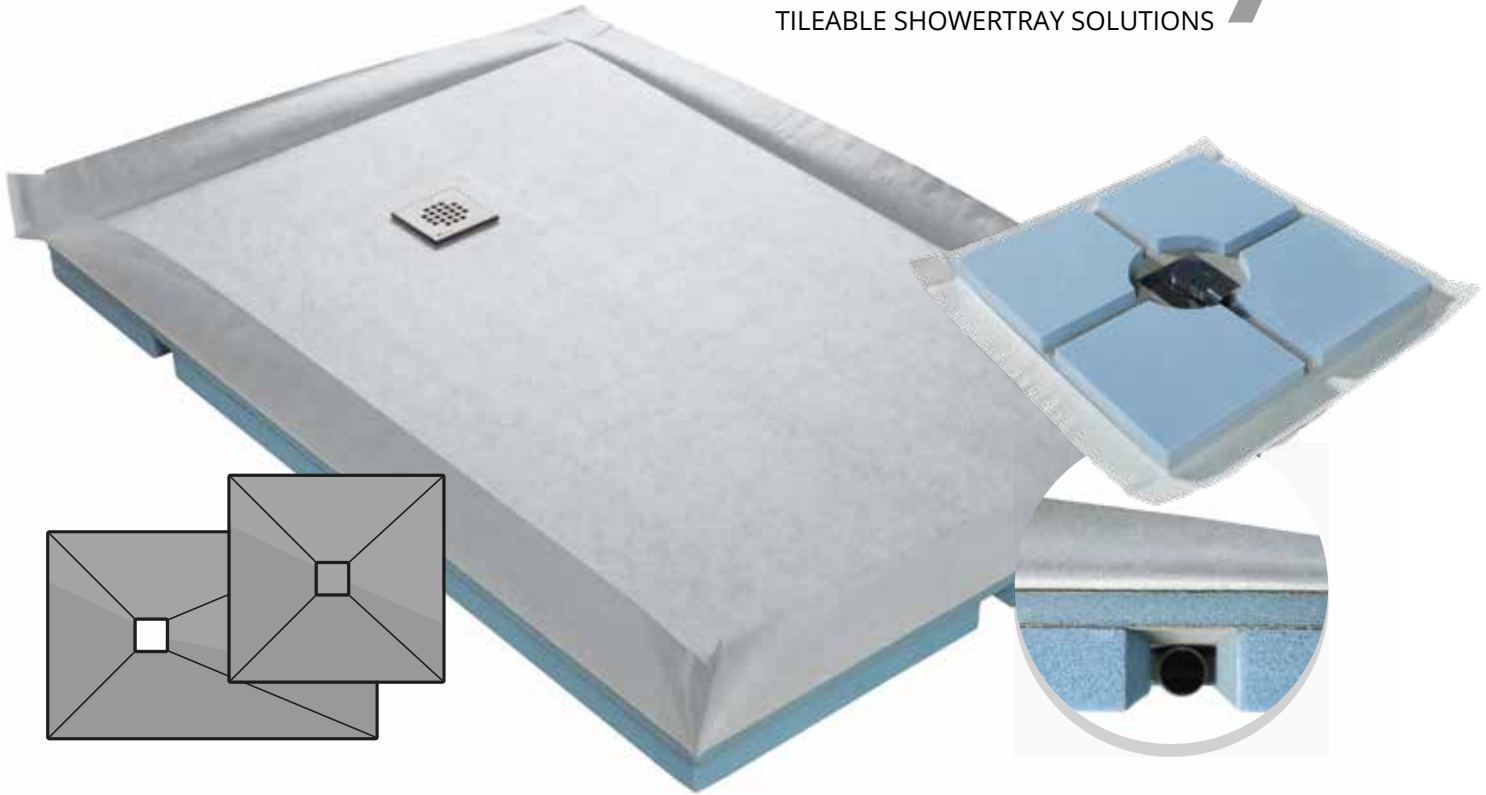

COMPACTBOARD

TILEABLE SHOWER TRAY

Standard tileable tray with ultra-low-profile trap, integrated riser and waterproof mat



INTEGRATED
WATERPROOF MAT
ULTRA LOW -PROFILE
2 CM SHOWER TRAY
INTEGRATED 4.5 CM
RISER THAT CAN BE CUT
ULTRA LOW-PROFILE
TRAP

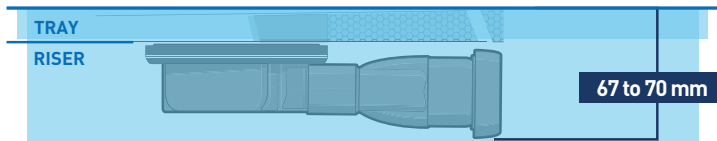

STANDARD GRID PROVIDED

SQUARE GRID (STANDARD)



OPTIONAL GRIDS

SQUARE GRID 2



ROUND GRID



DIAGONAL GRID

REF	DESCRIPTION	FORMAT	LENGTH (MM)	WIDTH (MM)	THICKNESS (MM)	POSITION OF TRAP
RC 90 COMPACT	COMPACTBOARD ULTRA-LOW-PROFILE SHOWERTRAY 67 MM	SQUARE FORMAT CENTRE TRAP	900	900	67	400/400
RC 100 COMPACT			1000	1000	67	450/450
RC 120 COMPACT			1200	1200	67	500/500
RC 12090 COMPACT			1200	900	67	600/600
RC 150100 COMPACT	COMPACTBOARD ULTRA-LOW-PROFILE SHOWERTRAY 70 MM	RECTANGULAR SHAPE OFFSET TRAP	1500	1000	70	320/500
RC 18590 COMPACT			1850	900	70	320/450

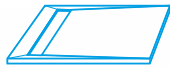

TILEABLE SHOWER TRAY SOLUTIONS
CHANNEL OUTLET

marmox
showerlay³⁶⁰
TILEABLE SHOWERTRAY SOLUTIONS



COMPACTBOARD LINE

TILEABLE SHOWER TRAY

Tileable shower tray with channel grid and ultra-low-profile trap and integrated waterproof mat. Special space saving solution for renovation following the Channel trend

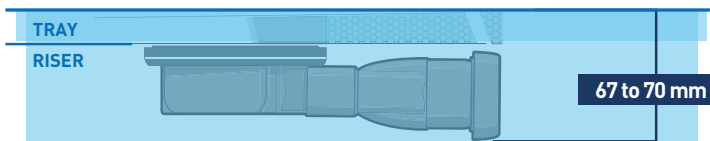

INNOVATION
ULTRA LOW-PROFILE
LIGHT
CAN BE CUT
INTEGRATED
WATERPROOF MAT
COMPATIBLE WITH ALL
TILES

REF	DESCRIPTION	FORMAT	LENGTH (MM)	WIDTH (MM)	DIS-PLACEMENT (MM)	POSITION OF TRAP
RC 90 COMPACT - LINE	COMPACTLINE 900 X 900 CHANNEL SHOWERTRAY WITH INTEGRATED RISER	RECTANGULAR SHAPE OFFSET TRAP	900	900	67	135/450
RC 100 COMPACT - LINE	COMPACTLINE 1000 X 1000 CHANNEL SHOWERTRAY WITH INTEGRATED RISER		1000	1000	67	135/500
RC 120 COMPACT - LINE	COMPACTLINE 1200 X 1200 CHANNEL SHOWERTRAY WITH INTEGRATED RISER		1200	1200	67	135/600
RC 12090 COMPACT - LINE	COMPACTLINE 1200 X 900 CHANNEL SHOWERTRAY WITH INTEGRATED RISER		1200	900	67	135/450
RC 150100 COMPACT - LINE	COMPACTLINE 1500 X 1000 CHANNEL SHOWERTRAY WITH INTEGRATED RISER		1500	1000	70	135/500
RC 18590 COMPACT - LINE	COMPACTLINE 1850 X 900 CHANNEL SHOWERTRAY WITH INTEGRATED RISER		1850	900	70	135/450

STANDARD GRID PROVIDED

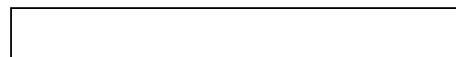

FULL GRID (STANDARD)

OPTIONAL GRIDS

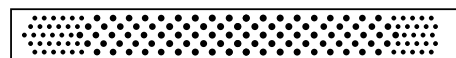

ROUND LINE GRID



SQUARE LINE GRID



TILEABLE GRID



TILEABLE SHOWER TRAY SOLUTIONS
CHANNEL OUTLET

marmox
showerlay³⁶⁰
TILEABLE SHOWERTRAY SOLUTIONS

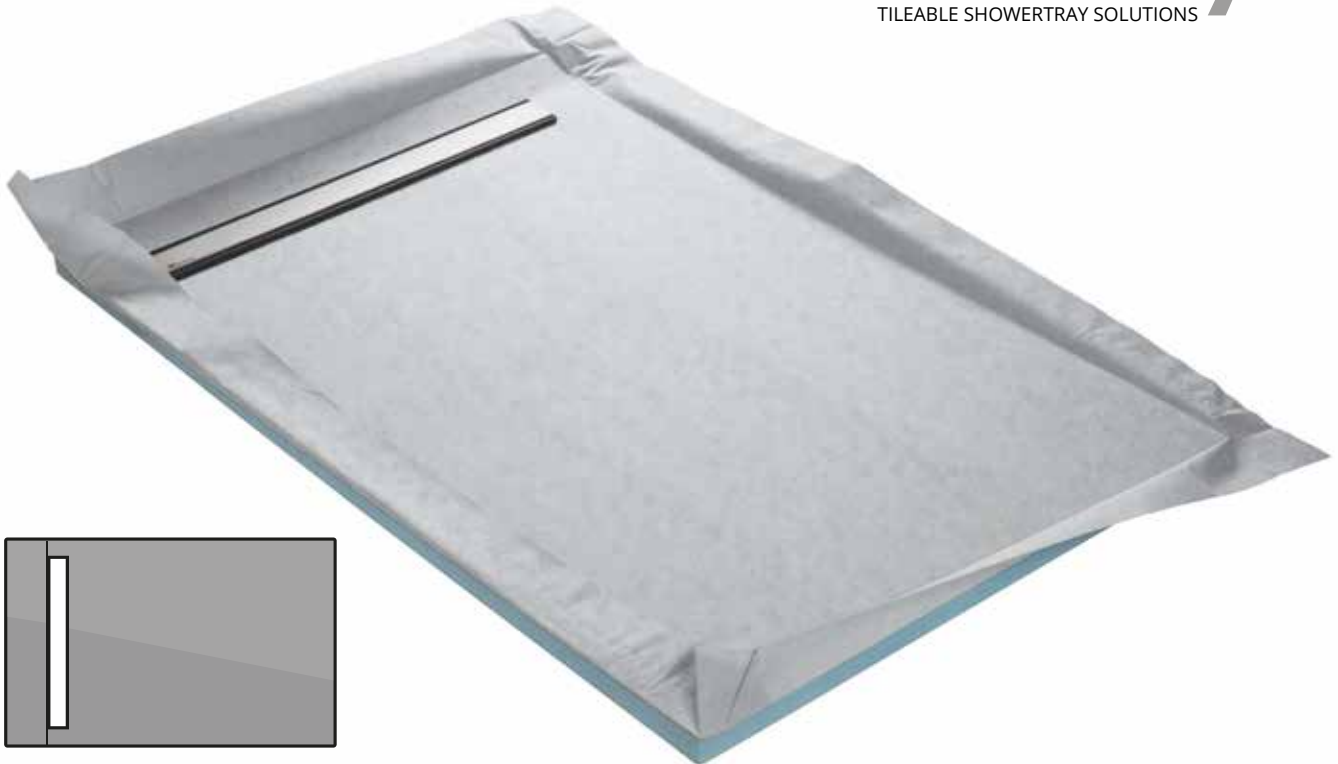

MONOBOARD

TILEABLE SHOWER TRAY

Tileable shower tray with channel grid and ultra-low-profile trap and integrated waterproof mat.

Special design solution for large size tiles
(Also available with °360 trap on request)

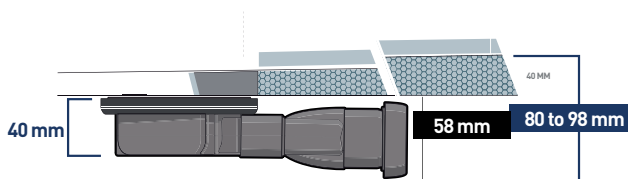

**LARGE
FORMAT
TILE
SOLUTION**

**LIGHT
EXTRA-LOW-PROFILE
CAN BE CUT
INTEGRATED
WATERPROOF MAT
COMPATIBLE WITH ALL
TILES
ULTRA LOW-PROFILE
TRAP**

STANDARD GRID PROVIDED

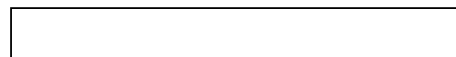

FULL GRID (STANDARD)

OPTIONAL GRIDS

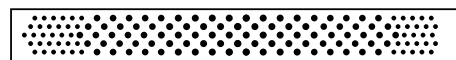

ROUND LINE GRID

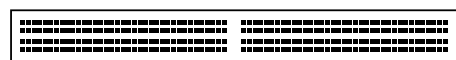

SQUARE LINE GRID

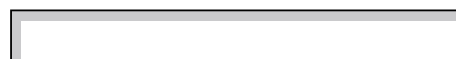

TILEABLE GRID

REF	DESCRIPTION	FORMAT	LENGTH (MM)	WIDTH (MM)	THICKNESS (MM)	POSITION OF TRAP
RC 12090	TILEABLE CHANNEL SHOWER TRAY MONOSLOPE 1200 X 900		1200	900	40	135/450
RC 14090	TILEABLE CHANNEL SHOWER TRAY MONOSLOPE 1400 X 900	RECTANGULAR SHAPE OFFSET TRAP	1500	1000	40	135/450
RC 150100	TILEABLE CHANNEL SHOWER TRAY MONOSLOPE 1500 X 1000		1500	1000	40	135/500
RC 185100	TILEABLE CHANNEL SHOWER TRAY MONOSLOPE 1850 X 1000		1850	1000	40	135/500

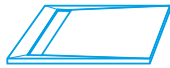

TILEABLE SHOWER TRAY SOLUTIONS
CHANNEL OUTLET

marmox
showerlay³⁶⁰
TILEABLE SHOWERTRAY SOLUTIONS

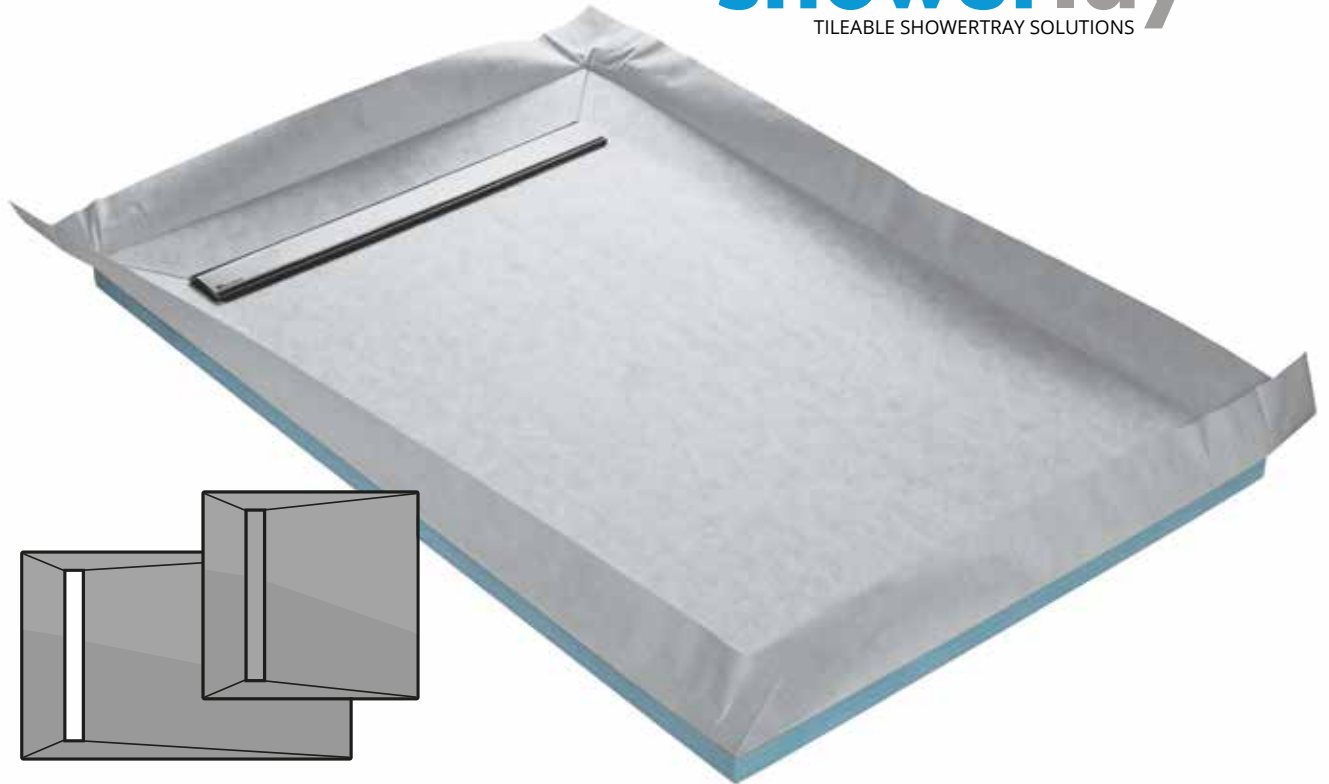

LINEBOARD

TILEABLE SHOWER TRAY

4 slopes, tileable shower tray with channel grid, ultra-low-profile trap and integrated waterproof mat.
Designer solution.
(Also available with °360 trap on request)

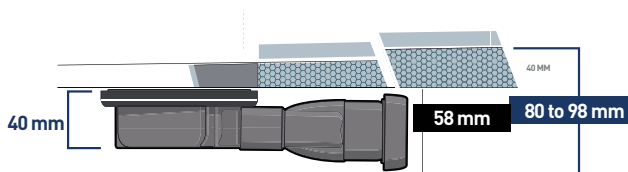

LIGHT
EXTRA-LOW PROFILE
CAN BE CUT
INTEGRATED
WATERPROOF MAT
COMPATIBLE WITH ALL
TILES
ULTRA LOW-PROFILE
TRAP

REF	DESCRIPTION	FORMAT	LENGTH (MM)	WIDTH (MM)	THICKNESS (MM)	POSITION OF TRAP
RC 90 LINE	TILEABLE SHOWER TRAY 900X900		900	900	40	135/450
RC 100 LINE	TILEABLE SHOWER TRAY 1000X1000		1000	1000	40	135/500
RC 120 LINE	TILEABLE SHOWER TRAY 1200X1200		1200	1200	40	135/600
RC 12090 LINE	TILEABLE SHOWER TRAY 1200X900	OFFSET BATH FORMAT	1200	900	40	135/450
RC 14090 LINE	TILEABLE SHOWER TRAY 1400X900		1400	900	40	135/450
RC 150100 LINE	TILEABLE SHOWER TRAY 1500X1000		1500	1000	40	135/500
RC 18590 LINE	TILEABLE SHOWER TRAY 1850X900		1850	900	40	135/450

STANDARD GRID PROVIDED

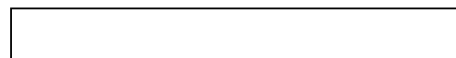

FULL GRID (STANDARD)

OPTIONAL GRIDS

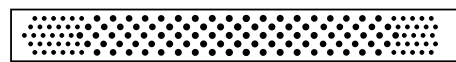

ROUND LINE GRID

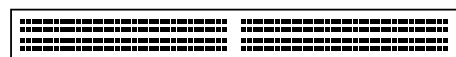

SQUARE LINE GRID



TILEABLE GRID



TILEABLE SHOWER TRAY SOLUTIONS

SQUARE OUTLET



FLATBOARD COMPLETE KIT

The tileable shower tray is often associated with many accessories, such as the polystyrene riser, the waterproofing kit, not to mention the wall waterproofing.

In addition to the traditional offer, our company has developed a kit for novices that includes not only all the elements to make a walk-in shower, but an educational installation video for all to understand

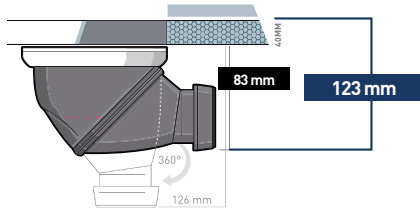

CONTENTS OF THE KIT

- Tileable shower tray with integrated waterproof mat
- 360 ° trap with grid-height spacer
- Stainless steel grid
- Extruded polystyrene riser system to fill the cavity
- Waterproof adhesive mortar to glue the risers and the shower tray
- Waterproof ready-to-tile wall mats to ensure watertight continuity up to 2.50 m
- Assembly video presenting all the stages of the construction of a walk-in shower

REF	DESCRIPTION	FORMAT	LENGTH (MM)	WIDTH (MM)	THICKNESS (MM)	QUANTITY PER PALLET
KIT 90 JAMES	TILEABLE SHOWER TRAY KIT 900X900		900	900	40	8
KIT 100 JAMES	TILEABLE SHOWER TRAY KIT 1000X1000	CENTRE	1000	1000	40	8
KIT 120 JAMES	TILEABLE SHOWER TRAY KIT 1200X1200		1200	1200	40	8
KIT 12090 JAMES	TILEABLE SHOWER TRAY KIT 1200X900	OFFSET BATH FORMAT	1200	900	40	8
KIT 18590 JAMES	TILEABLE SHOWER TRAY KIT 1850X900		1400	900	40	8

marmox showerlay³⁶⁰

TILEABLE SHOWERTRAY SOLUTIONS

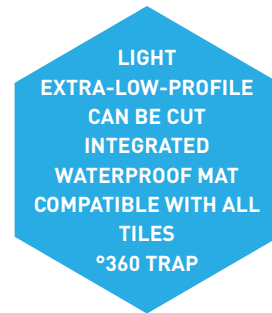

SQUARE GRID PROVIDED

SQUARE GRID (STANDARD)



OPTIONAL GRIDS

SQUARE GRID 2



ROUND GRID



DIAGONAL GRID



TILEABLE SHOWER TRAY SOLUTIONS
CHANNEL OUTLET



LINEBOARD COMPLETE KIT

As per our complete Flatboard kit,
we offer a complete kit with the channel grid option

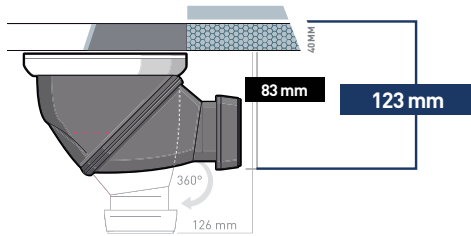

CONTENTS OF THE KIT

- Tileable shower tray with integrated waterproof mat
- 360 ° trap with grid-height spacer
- Stainless steel grid
- Extruded polystyrene riser system to fill the cavity
- Waterproof adhesive mortar to glue the risers and the shower tray
- Waterproof ready-to-tile wall mats to ensure watertight continuity up to 2.50 m
- Assembly video presenting all the stages of the construction of a walk-in shower

REF	DESCRIPTION	FORMAT	LENGTH (MM)	WIDTH (MM)	THICKNESS (MM)	QUANTITY PER PALLET
KIT 90 CANIV	TILEABLE SHOWER TRAY KIT 900X900		900	900	40	8
KIT 100 CANIV	TILEABLE SHOWER TRAY KIT 1000X1000		1000	1000	40	8
KIT 120 CANIV	TILEABLE SHOWER TRAY KIT 1200X1200	OFFSET BATH FORMAT	1200	1200	40	8
KIT 12090 CANIV	TILEABLE SHOWER TRAY KIT 1200X900		1200	900	40	8
KIT 18590 CANIV	TILEABLE SHOWER TRAY KIT 1850X900		1400	900	40	8

marmox showerlay³⁶⁰

TILEABLE SHOWERTRAY SOLUTIONS

LIGHT
EXTRA-LOW-PROFILE
CAN BE CUT
INTEGRATED
WATERPROOF MAT
COMPATIBLE WITH ALL
TILES
°360 TRAP

STANDARD GRID PROVIDED

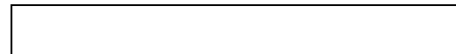

FULL GRID (STANDARD)

OPTIONAL GRIDS

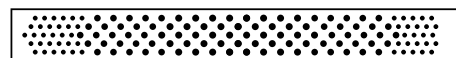

ROUND LINE GRID



SQUARE LINE GRID



TILEABLE GRID



SUMMARY TABLE TILEABLE SHOWER TRAYS

FLATBOARD® SHOWER TRAYS
SQUARE OR RECTANGULAR
360° ORIENTABLE
(OR ULTRA-LOW-PROFILE) TRAP VERSION

REF	X LENGTH (MM)	Y WIDTH (MM)	Z2 / Z1 POSITION OF TRAP	E THICKNESS OF TRAY (MM)	F DISPLACEMENT UNDER TRAY (MM)	T TOTAL DISPLACEMENT INCLUDING TRAY (MM)
RC 80 FLAT	800	800	400/400	40	"83 (JAMES °360 TRAP) / 58 (SLIM ULTRA-LOW- PROFILE TRAP)"	"123 (JAMES °360 TRAP) / 98 (SLIM ULTRA- LOW-PROFILE TRAP)"
RC 90 FLAT	900	900	450/450			
RC 100 FLAT	1000	1000	500/500			
RC 120 FLAT	1200	1200	600/600			
RC 150 FLAT	1500	1500	750/750			
RC 12090 FLAT	1200	900	320/450			
RC 14090 FLAT	1400	900	320/450			
RC 16090 FLAT	1600	900	320/450			
RC 150100 FLAT	1500	1000	320/500			
RC 18590 FLAT	1850	900	320/450			
RC 200100 FLAT	2000	1000	320/500			
RC 12090 CENTRE	1200	900	600/450			
RC 18590 CENTRE	1850	900	925/450			

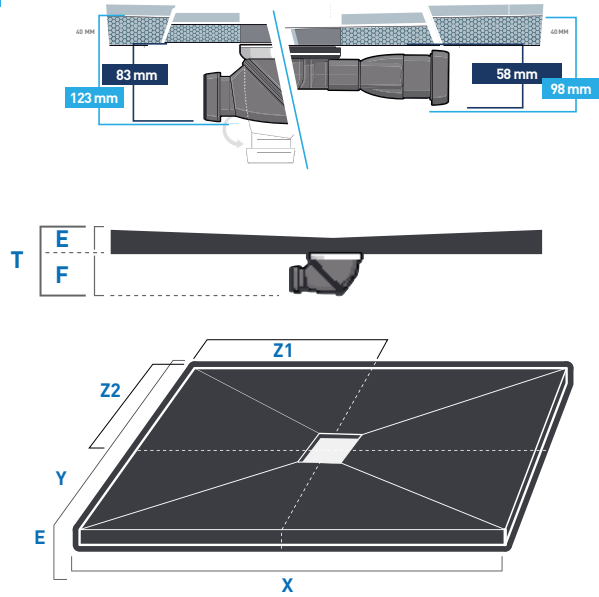

SLIMBOARD® SHOWER TRAYS
SQUARE OR RECTANGULAR
ULTRA-LOW-PROFILE TRAP VERSION

REF	X LENGTH (MM)	Y WIDTH (MM)	Z2 / Z1 POSITION OF TRAP	E THICKNESS OF TRAY (MM)	F DISPLACEMENT UNDER TRAY (MM)	T TOTAL DISPLACEMENT INCLUDING TRAY (MM)
RC 90 SLIM	900	900	450/450	22	40 TO 58	62 TO 83
RC 100 SLIM	1000	1000	500/500			
RC 120 SLIM	1200	1200	600/600			
RC 12090 SLIM	1200	900	320/450	25		
RC 150100 SLIM	1500	1000	320/500			
RC 18590 SLIM	1850	900	320/450			

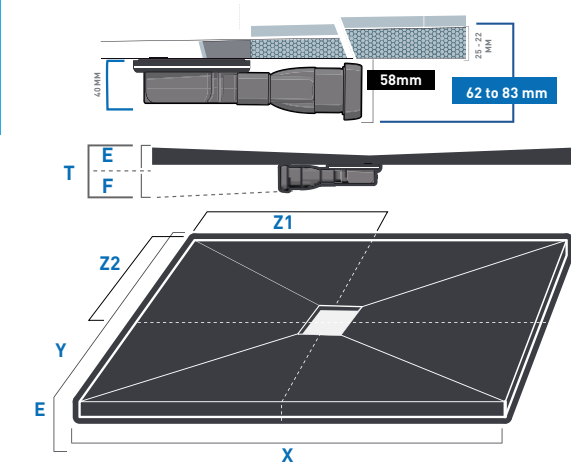

COMPACTBOARD® SHOWER TRAYS
SQUARE OR RECTANGULAR
ULTRA-LOW-PROFILE TRAP VERSION

REF	X LENGTH (MM)	Y WIDTH (MM)	Z2 / Z1 POSITION OF TRAP	E THICKNESS OF TRAY (MM)
RC 90 COMPACT	900	900	450/450	67
RC 100 COMPACT	1000	1000	500/500	
RC 120 COMPACT	1200	1200	600/600	
RC 12090 COMPACT	1200	900	320/450	70
RC 150100 COMPACT	1500	1000	320/500	
RC 18590 COMPACT	1850	900	320/450	

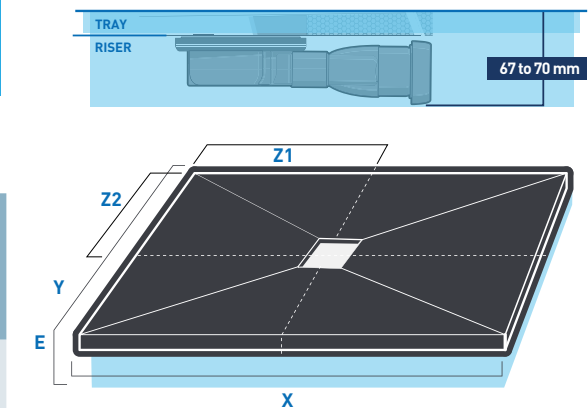



SUMMARY TABLE TILEABLE SHOWER TRAYS

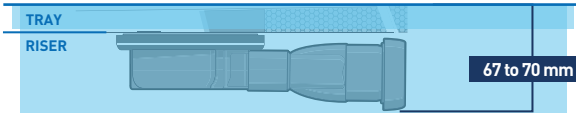

COMPACTLINE® SHOWER TRAYS SQUARE OR RECTANGULAR ULTRA-LOW-PROFILE TRAP VERSION

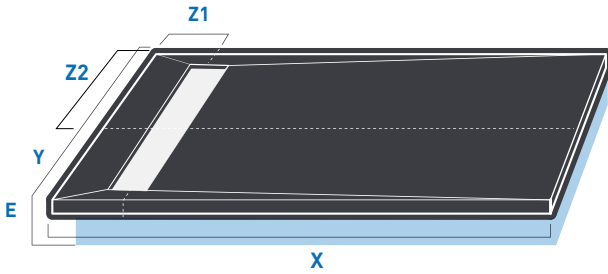

REF	X LENGTH (MM)	Y WIDTH (MM)	Z2 / Z1 POSITION OF TRAP	E THICKNESS OF TRAY (MM)
RC 90 COMPACT - LINE	900	900	135/450	67
RC 100 COMPACT - LINE	1000	1000	135/500	67
RC 120 COMPACT - LINE	1200	1200	135/600	70
RC 12090 COMPACT - LINE	1200	900	135/450	67
RC 150100 COMPACT - LINE	1500	1000	135/500	70
RC 18590 COMPACT - LINE	1850	900	135/450	70

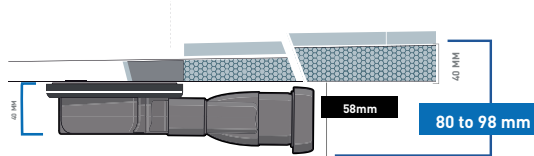

LINEBOARD® SHOWER TRAYS SQUARE OR RECTANGULAR ULTRA-LOW-PROFILE CHANNEL TRAP VERSION

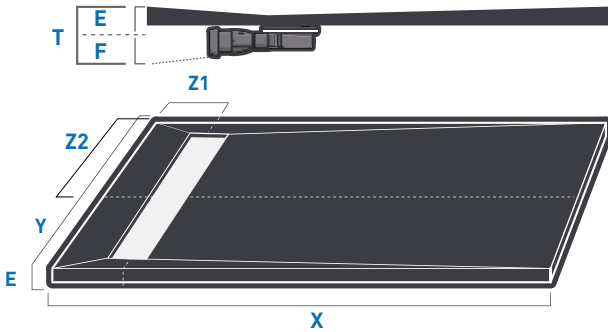

REF	X LENGTH (MM)	Y WIDTH (MM)	Z2 / Z1 POSITION OF TRAP	E THICKNESS OF TRAY (MM)	F DISPLACEMENT UNDER TRAY (MM)	T TOTAL DISPLACEMENT INCLUDING TRAY (MM)
RC 90 LINE	900	900	135/450	40	40 TO 58	80 TO 98
RC 100 LINE	1000	1000	135/500			
RC 120 LINE	1200	1200	135/600			
RC 12090 LINE	1200	900	135/450			
RC 150100 LINE	1500	1000	135/500			
RC 18590 LINE	1850	900	135/450			

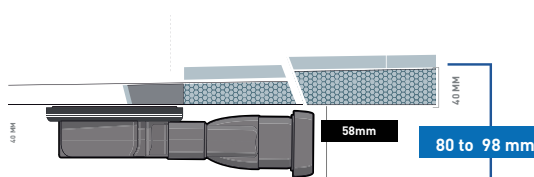

MONOBOARD® SHOWER TRAYS SQUARE OR RECTANGULAR ULTRA-LOW-PROFILE CHANNEL TRAP VERSION

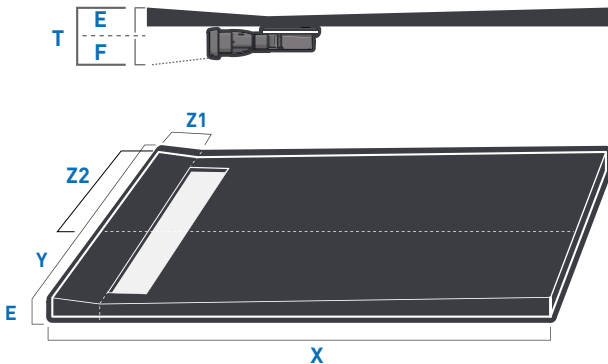

REF	X LENGTH (MM)	Y WIDTH (MM)	Z2 / Z1 POSITION OF TRAP	E THICKNESS OF TRAY (MM)	F DISPLACEMENT UNDER TRAY (MM)	T TOTAL DISPLACEMENT INCLUDING TRAY (MM)
RC 12090 LINE	1200	900	135/450	40	40 TO 58	80 TO 98
RC 14090 LINE	1400	900	135/450			
RC 150100 LINE	1500	1000	135/500			
RC 185100 LINE	1850	1000	135/500			



SUMMARY DIMENSION TABLES

COMPLETE KITS

COMPLETE KIT FLATBOARD

REF	THICKNESS (MM)	LENGTH (MM)	WIDTH (MM)
KIT 90 JAMES	40	900	900
KIT 100 JAMES	40	1000	1000
KIT 120 JAMES	40	1200	1200
KIT 12090 JAMES	40	1200	900
KIT 18590 JAMES	40	1400	900

COMPLETE KIT LINEBOARD

REF	THICKNESS (MM)	LENGTH (MM)	WIDTH (MM)
KIT 90 CANIV	40	900	900
KIT 100 CANIV	40	1000	1000
KIT 120 CANIV	40	1200	1200
KIT 12090 CANIV	40	1200	900
KIT 18590 CANIV	40	1400	900



SUMMARY TABLE

FLOOR DRAIN SOLUTIONS

FLOOR DRAIN

REF	DESCRIPTION	UNDERLAY SIZE (MM)	GRID WIDTH (MM)	GRID LENGTH (MM)	UNDERLAY THICKNESS (MM)
RC 20 ACIER	°360 FLOOR DRAIN	200 X 200	115	115	10
RC 20 SLIM	ULTRA-LOW-PROFILE FLOOR DRAIN	200 X 200	115	115	10

SHOWER CHANNEL

REF	TOTAL LENGTH (MM)	GRID LENGTH (MM)	TOTAL WIDTH (MM)	GRID WIDTH (MM)	DISPLACEMENT UNDER CHANNEL - HORIZONTAL VERSION (MM)	DISPLACEMENT UNDER CHANNEL - VERTICAL VERSION (MM)
LD 70	750	700	140	70	83	123
LD 80	850	800				
LD 90	950	900				
LD 100	1050	1000				
LD 120	1250	1200				

REF	DESCRIPTION	TOTAL LENGTH (MM)	GRID LENGTH (MM)	TOTAL WIDTH (MM)	GRID WIDTH (MM)	DISPLACEMENT UNDER CHANNEL (MM)	WEIGHT (KG)	QUANTITY PER BOX
LD 70 JAMES	FLOOR DRAIN CHANNEL WITH °360 TRAP	750	700	250	70	83	3	1 Piece
LD 70 SLIM	FLOOR DRAIN CHANNEL WITH SLIM ULTRA-LOW-PROFILE TRAP	750	700	250	70	45	3	1 Piece



SUMMARY DIMENSION TABLES CONSTRUCTION PANELS

STANDARD PANELS

REF	DESCRIPTION	THICKNESS (MM)	WIDTH (MM)	LENGTH (MM)	U VALUE (W/m2K)	R VALUE (m2.K/W)	QUANTITY PER PALLET
4 EB 125	PANEL 1250 X 600 X 4	4	600 900 1200	1250	9.9	0.06	165
6 EB 125	PANEL 1250 X 600 X 6	6			7	0.12	150
10 EB 250	PANEL 2500 X 600 X 10	10		2500	3.5	0.25	215
125 EB 250	PANEL 2500 X 600 X 12.5	12.5			2.7	0.33	150
20 EB 250	PANEL 2500 X 600 X 20	20			1.5	0.56	106
30 EB 250	PANEL 2500 X 600 X 30	30			1	0.86	75
40 EB 250	PANEL 2500 X 600 X 40	40			0.7	1.16	60
50 EB 250	PANEL 2500 X 600 X 50	50			0.57	1.47	45
80 EB 250	PANEL 2500 X 600 X 80	80	0.5	2.33	25		

BATH PANEL

REF	DESCRIPTION	THICKNESS (MM)	WIDTH (MM)	LENGTH (MM)	WEIGHT PER PANEL (KG)	QUANTITY PER PALLET
30 EB 55 185	BATH PANEL WITHOUT FEET	30	550	1850	2.4	75
30 EB 177			600	1770	2.4	75
30 TAB 90	BATH PANEL WITH FEET	30	600	900	1.2	75
30 TAB 180			600	1800	2.4	75

TOILET CISTERN PANEL

REF	DESCRIPTION	THICKNESS (MM)	WIDTH (MM)	LENGTH (MM)	WEIGHT (KG)
TOILET BOARD	TOILET CISTERN PANEL - PRE CUT -	20	1200	1550	4
TOILET BOX	TILEABLE SUPPORT FRAME CLADDING KIT	30	600	1250	4

PIPE BOXING PANEL

REF	DESCRIPTION	THICKNESS (MM)	WIDTH (MM)	LENGTH (MM)	WEIGHT PER PANEL (KG)	QUANTITY PER PALLET
20 ANG 150	PIPE BOXING PANEL 15 X 15 CM	20	150 x 150	2500	2	75
20 ANG 200	PIPE BOXING PANEL 20 X 20 CM		200 x 200		2.5	75
20 ANG 300	PIPE BOXING PANEL 30 X 30 CM		300 x 300		4	75
20 ANG 400200	PIPE BOXING PANEL 40 X 20 CM		400 x 200		4	75

FLEX PANELS

REF	DESCRIPTION	THICKNESS (MM)	WIDTH (MM)	LENGTH (MM)	WEIGHT PER PANEL (KG)	QUANTITY PER PALLET
20/30 JAGL 250	FLEX PANEL - ALONG LENGTH	20/30	600	2500	3.5/4	115/75
20/30 JAGW 250	FLEX PANEL - ALONG WIDTH					

TILEABLE SHELVES

REF	DESCRIPTION	THICKNESS (MM)	WIDTH (MM)	LENGTH (MM)	WEIGHT PER PANEL (KG)	QUANTITY PER PALLET
TILE CORNER	TILEABLE SHELF FOR BATHROOM	30	240	240	0.5	1 Piece

TILEABLE NICHE

REF	DESCRIPTION	THICKNESS (MM)	DEPTH (MM)	LENGTH (MM)	WIDTH (MM)	WEIGHT (KG)	QUANTITY PER BOX
NICHE 4020	TILEABLE NICHE FOR BATHROOM	10	100	400	200	2	1 Piece
NICHE 4030					300		
NICHE 4040					400		
NICHE 8025				800	250	2.5	

MERCHANDISING TOOLS

AT YOUR DISPOSAL

PYRAMID FOR TILEABLE PANELS

30 x 30 cm pyramid with all thicknesses of panels to be tiled. Ideal for counters and technical corners in showrooms.

REF PYRAMID

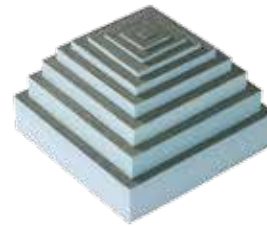

MINI TILEABLE SHOWER TRAY

50 x 50 cm model to present tileable shower trays with integrated waterproof mat and trap. Ideal for counters and for external reps.

REF RC50FLAT (James trap) or **RC50SLIM** (Slim trap)



SHORT MERCHANDISING DISPLAY FOR THIN BOARDS

Low cabinet of 1.4m with a 60x60cm small footprint. Ideal to integrate in technical corners. Possible to fit up to 100 thin panels in 4mm and 6mm

REF MEUBLE 60



TALL MERCHANDISING DISPLAY - 1 METRE

Tall cabinet of 2.70m x 1.00 m x 60cm. Ideal to integrate in technical corners. Allows the integration of 1.25 m and 2.50 m high panels of different thicknesses for optimized stock.

REF MEUBLE 100



TALL MERCHANDISING DISPLAY - 2 METRE

Tall cabinet of 2.70m x 2.00 m x 60cm. Ideal to integrate in technical corners. Allows the integration of 1.25 m and 2.50 m high panels of different thicknesses for optimized stock.

REF MEUBLE 200





MARMOX Egypt S.A.E

43 El Haram St.

Giza, Egypt.

Tel.: +202 35 85 40 84

Fax: +202 35 85 98 58

E-Mail: info@marmoxegypt.com

www.marmox.com



www.marmox.com

